

*A guide to
buying an
IKEA kitchen*

IKEA KITCHENS

Whether you're looking for a complete kitchen system like SEKTION or one of our other kitchens, this buying guide includes the products, prices and helpful information you need to choose the kitchen of your dreams.

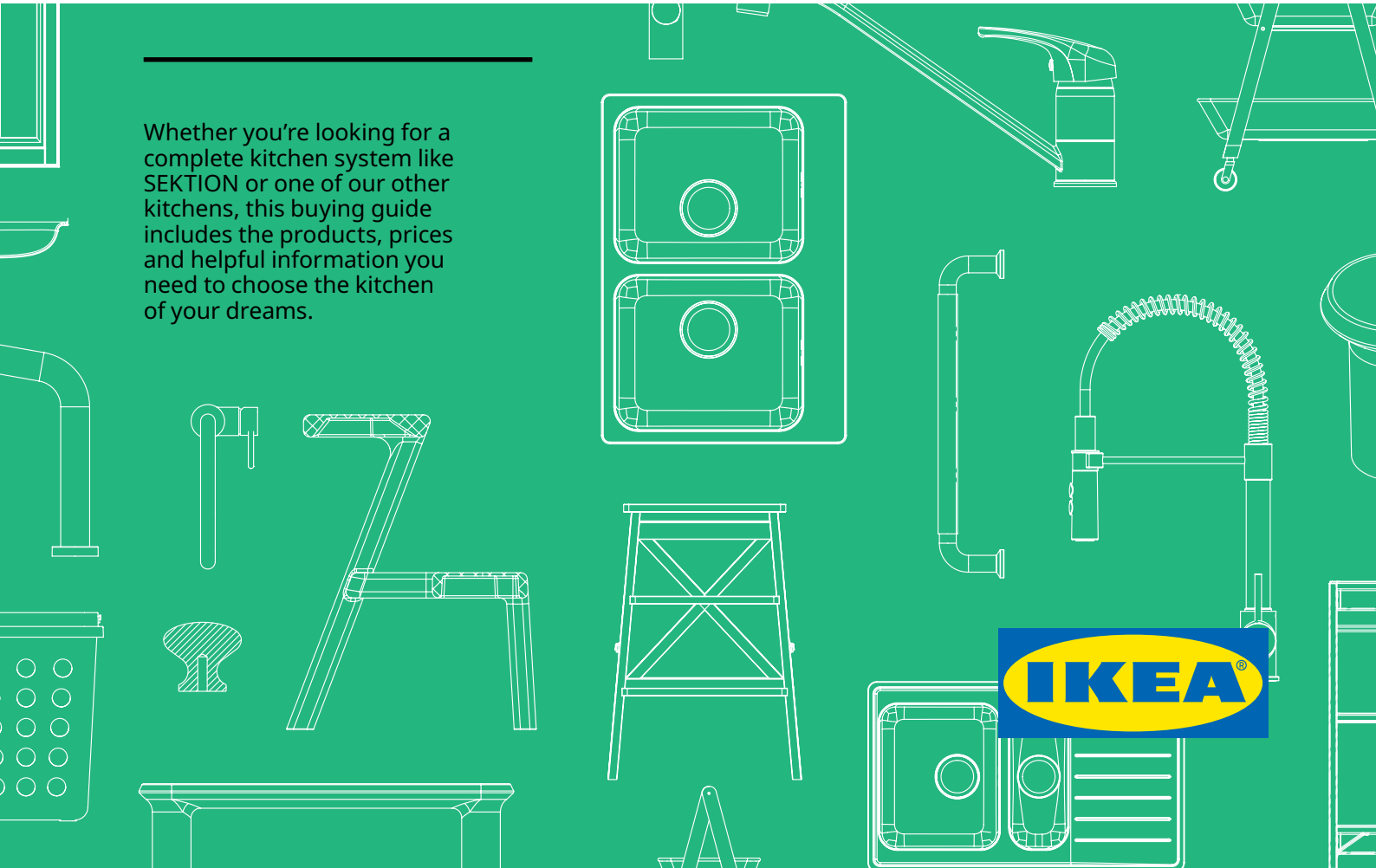



Sinks and faucets.
See pages 62-73



Working in your kitchen is safer, easier and a lot more enjoyable with good lighting on the countertop, behind glass doors and in drawers. See page 36



You can do everything yourself, but you don't have to. With our broad service offer we can assist you with everything from measuring and planning to complete kitchen installation. See page 6



Table of contents

Steps to buying an IKEA kitchen	4	ENHET kitchen system	90
Services	6	ENHET complete kitchens.....	92
IKEA Kitchens	8	ENHET storage combinations.....	98
SEKTION kitchen system	10	ENHET doors and drawer fronts	102
Doors and drawer fronts	12	ENHET cabinets and frames.....	106
Cover panels, decorative moldings, toekicks and legs	24	Lighting for ENHET.....	112
Lighting and sound	36	Kitchen accessories, carts and islands.....	116
Countertops	42	Knobs and handles.....	126
Wall panels.....	60	KNOXHULT kitchen	130
Sinks	62	SUNNERSTA mini-kitchen	134
Kitchen faucets	68	Limited Warranties	136
SEKTION cabinets.....	74		
SEKTION interior fittings and organizers	84		



Looking for extra counter space and storage? An island can do both. The thick oak veneer countertop of TORNVIKEN kitchen island is a durable natural material that can be sanded and surface treated when required. Oak is an exceedingly strong and durable hardwood with a prominent grain. It darkens beautifully with age, acquiring a golden-brown undertone. 10-year Limited Warranty. See page 136

Life in the kitchen goes a lot smoother when your drawers open up fully to help you reach everything. With interior fittings and organizers inside cabinets and drawers, finding what you're looking for will be easy-peasy. See page 84

Steps to buying an IKEA kitchen

IKEA kitchens are designed so that you can install them yourself. To the right are some steps to ensure the process goes well for you. Should you have any questions, don't hesitate to talk to our kitchen experts at your local IKEA store or visit us at: [IKEA-USA.com](https://www.ikea.com/us/en)



Find your style

It's time to dream a little, look at some ideas, consider your needs and decide what an ideal kitchen means for you. This buying guide is made to give you an overview of some of the possibilities, but there is so much more. You can find more ideas and inspiration on our website, in the kitchen brochure or by visiting your local IKEA store.



Measure

When measuring it's important to take your time and get your measurements correct. This will form the foundation of all your planning. To see exactly what to measure, pick up a copy of the planning guide *Your new IKEA kitchen* at your local IKEA store or at [IKEA-USA.com/buyingguide](https://www.ikea.com/us/en/buyingguide).

→ **We can do it for you**
To learn more about our Measuring services see [page 6](#)



Plan

Planning your kitchen is when your dreams and ideas take shape. Use the online IKEA Home Planner tool to start planning your kitchen. Or, if you would like some advice we have kitchen planners ready in the store to help.

→ **We can do it for you**
To learn more about our Kitchen planning services, view [page 6](#)



Order

When you're satisfied with your planning, visit your local IKEA store and talk to our kitchen experts. They will go over your kitchen plan with you, and help you with anything you're not sure about. When you are ready you can order and we can help with delivery.

→ **We can do it for you**
To learn more about our Delivery service, see [page 7](#)



Install

IKEA kitchens are designed to be installed by you, but we're here to offer as much help as you feel you need. You can start by picking up the kitchen installation guide from the store, which gives step-by-step instructions on installing your kitchen.

→ **We can do it for you**
To learn more about our Kitchen installation service, view [page 7](#)

Services

You can do it yourself, but you don't have to

Our service offer gives you the freedom to design your own price tag by choosing not only the products that suit your budget but also by deciding how much you want to do yourself and how much you want us to do for you. On this page you'll find the different services that are available to help and support you. For more details about our services, talk to a co-worker at your local IKEA store or visit us at [IKEA-USA.com/kitchenservices](https://www.ikea.com/us/en/kitchenservices)



Kitchen Measurement Service

It's important to have your kitchen accurately measured before planning begins. An experienced IKEA Measurement Technician will come to your home, take all of the essential measurements, and enter the data in the IKEA Home Planner. Your Measurement Service fee is refunded when you have IKEA install your kitchen. Available for customers living within our service area.

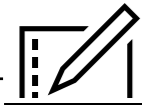

IKEA Home Planner

You can plan your kitchen on your computer with our online 3D IKEA Home Planner at [IKEA-USA.com/kitchenplanner](https://www.ikea.com/us/en/kitchenplanner). It's free, it's fun and it calculates your price as you click along. You can PRINT, SAVE and CHANGE your kitchen plan as many times as you want. Then come to the store and get advice — you can access the same plan you've been working on — and share it with our IKEA Kitchen Specialists.

Services and prices may vary. For more information about our services, visit [IKEA-USA.com/services](https://www.ikea.com/us/en/services) or your local IKEA store.

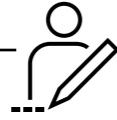

Free Kitchen Planning Service

We offer two **no cost** options to have your kitchen professionally planned. You will receive a detailed layout of your kitchen including cabinets, appliances, and countertops, and a parts list to make it easy to order.

Most Convenient & available to everyone in the continental US:

Planning from Your Home Make a 90-minute appointment, online or in your local IKEA store. Allow time for you to measure your kitchen and select products before your appointment. A professional IKEA Kitchen Planner will work with you interactively online to plan your dream kitchen. You will be able to discuss every detail and view your plan being created. Your planner will follow-up with a second session to make any changes.

Visit an IKEA store:

Planning from the Store You can make an appointment online or at your local IKEA store for a two-hour in-store appointment with one of our professional IKEA Kitchen Planners. Allow time for measuring your kitchen and selecting products before your planning appointment.

Prior to your appointment, you will need to:

- **Measure your space** – The first step is getting your kitchen measurements. Instructions will be provided if you want to do this yourself. But if you live in an IKEA service area, a professional IKEA measurement technician can visit your home to measure your kitchen for you.
- **Choose your products** – Start browsing our kitchen products now to get a better understanding of what you want. You must know this before your planning session to make it productive.

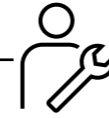

IKEA Kitchen Installation Service

Professional IKEA kitchen installation makes your dream kitchen come true. Check with your local store to see if installation is available in your area. Professional kitchen installers will handle assembling and installing your IKEA cabinets, doors, drawers, interior fittings, handles and knobs. Your kitchen will be installed to the highest industry standards.

Kitchen installation includes:

- Assemble cabinets, drawers, doors and interior fittings
- Install IKEA cabinets, toekicks and side cover panels (excludes 26x36" and 36x96" panels)
- Adjust all IKEA cabinet doors and drawer fronts for appearance
- Clean-up of your kitchen job site, which includes:
 - Daily broom cleaning of job site
 - Vacuum inside of cabinets, floors, and other surfaces upon completion of installation
- Attach IKEA knobs and/or handles to cabinet doors and drawers

Installation Price Quote

Upon completion of your Kitchen Plan on our IKEA Home Planner, we can schedule your Installation Price Quote. An experienced professional from IKEA will contact you and provide an itemized installation price quotation.

Installation Price Quote

- Confirmation of the scope of kitchen installation.
- Confirmation of the time schedule of kitchen installation.
- Confirmation of the price of kitchen installation.

Services and prices may vary. For more information about our services, visit [IKEA-USA.com/services](https://www.ikea.com/us/en/services) or your local store.

5-Year Warranty

Professional Kitchen Installers are professional, licensed, insured and warranty their work for 5 years post completion on IKEA supplied kitchen products.*

*Installation warranty is for the installation of IKEA kitchen products only. In the event of defects in workmanship, the IKEA product or materials will be repaired or replaced; provided, that the defect was not due to a product defect, normal wear and tear, accidents, alteration by the customer, misuse, abuse, or neglect.



Delivery

Whether you're shopping in the store or online, and no matter how big the purchase, we can help do the heavy lifting and arrange delivery, by an Independent Service Provider, to your home or business.



IKEA Projekt Credit Card

Your dream home is now within reach. With the special financing options on our IKEA Projekt credit card*, you don't have to put off loving every room in your home.

*Subject to credit approval. IKEA Projekt Credit Card Accounts are issued by Comenity Capital Bank. To learn more visit [IKEA-USA.com/creditcard](https://www.ikea.com/us/en/creditcard) or drop by your local store.



What type of kitchen are you looking for?

Whether you're looking for a complete kitchen system like SEKTION that you can personalize any way you want, or a simpler kitchen that you can install in a day, we have what you're looking for. Here you have four different types of IKEA kitchens to suit different needs and wishes.



SEKTION kitchen system

Our SEKTION kitchen system includes cabinets in several different sizes to fit your room layout as well as your kitchen routines. The flexibility of the system offers endless choices, giving you the freedom to build a kitchen that's ideal for you and your space. We've also developed an extensive range of kitchen organizers and interior fittings allowing you to quickly see and reach even the things farthest back in the corner cabinets. In addition you have a vast choice in front expressions, countertops, lighting, sinks, faucets, knobs, handles and much more to personalize every inch of your kitchen. **See pages 10–89**

ENHET kitchen

Whatever shape your homes takes, your ENHET kitchen will fit right in. Find pre-combined and affordable solutions online and assemble them without special tools — they are simply clicked together. ENHET gives you great freedom to personalize your kitchen, offering open and closed storage, doors in different colors, as well as different accessories. **See page 90–115**



KNOXHULT kitchen

KNOXHULT comes in pre-packaged modules that you can arrange the way you prefer. Together with our appliances you can get a complete kitchen with all the basic functions you need at a very low price. Add sink, faucet, knobs and handles of your choice to complete the look. The simplicity of the pre-packaged modules makes the installation so easy that you can have a fully functional kitchen up and running the same day you bring it home from the IKEA store. **See pages 130–133**



SUNNERSTA mini-kitchen

If you like to keep it simple and don't need an elaborate kitchen, SUNNERSTA might be a perfect fit for you. This flexible mini-kitchen is easy to buy, get home, install and take with you if you move somewhere else. Add the TILLREDA compact fridge and portable induction cooktop and you'll have the basic functions you need for a small space apartment, guest house, dorm room or wherever you might cook your next meal. **See page 134–135**

SEKTION KITCHEN SYSTEM

Endless possibilities

The modular design of SEKTION kitchen system is easy to install and gives you endless possibilities when designing your kitchen. Whether you have a taste for the traditional, love the minimalism in modern style or land somewhere in between, you'll surely find something that fits you.

To become truly beautiful, the kitchen has to be functional and take care of all your kitchen needs, too. With SEKTION you have the freedom to get the look you

want on the outside and keep everything in perfect order on the inside. Start by deciding the style of your dream kitchen by choosing the doors and drawer fronts, lighting, countertop, sink, faucet, knobs, handles and accessories that you like.

25

IKEA SEKTION kitchen has a free 25-year limited warranty. Find out more on [page 136](#)



Doors and drawer fronts

Choose your style!

No matter what your personal style and preference is, make sure to choose a kitchen front you will love for years to come. It is the face of your kitchen, and most likely you will spend many hours in it.

We have a wide range of materials and finishes to choose from to suit your style — no matter what you like! Everything from traditional doors and drawer fronts that are rich in details, to high-gloss and modern doors and drawer fronts with integrated handles to give you that open clean look — we have it!

The process of choosing the style of your kitchen is all up to you, go for whatever you like — it is your kitchen! We have made sure that all our fronts are durable and of high quality. They all come with a free 25-year limited warranty to ensure that whatever you choose, it will last for years to come.

25

IKEA SEKTION kitchen has a free 25-year limited warranty. Find out more on [page 136](#)



Door and drawer front styles



Sleek doors and drawer fronts

Sleek doors offers you straight lines and smooth, easy to clean surfaces, simplicity in its truest form. Choose from a wide variety of finishes, colors and materials.



Frame doors and drawer fronts

Frame doors and drawer fronts are rich in detail, with a crafted look and feel—they create a kitchen with a rustic and traditional look. All our frame door families have a matching glass door.



High-gloss doors and drawer fronts

Glossy surfaces suit everyone from the minimalist to the wild family with kids. Stains are no problem as they are just as easy to wipe clean as they were to make.



Doors and drawer fronts with integrated handles

You might not notice them at first glance — and that's the idea! Integrated handles lend a minimalistic and modern feeling to your kitchen.

Sleek doors and drawer fronts



VEDDINGE

Color/design: White
Material: Painted finish

VEDDINGE white is a smooth, sleek door that gives your kitchen a bright, modern look. Complement with JUTIS accent door.

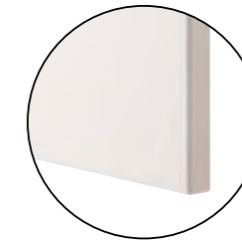

HAVSTORP

Color/design: Beige
Material: Painted finish

HAVSTORP lacquered doors are smooth and seamless, resistant to moisture and staining and very easy to keep clean. Complement with JUTIS glass door.

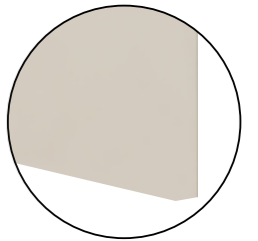

HAVSTORP

Color/design: Turquoise
Material: Painted finish

HAVSTORP lacquered doors are smooth and seamless, resistant to moisture and staining and very easy to keep clean. Complement with JUTIS glass door.

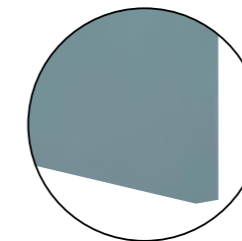

SINARP

Color/design: Brown
Material: Stain and lacquer finish

SINARP offers a timeless design with a modern twist, in dark wood tones that are full of character. The solid oak edging elegantly outlines the front adding fine detail and warmth to your kitchen. Complement with JUTIS glass door.



Sleek doors and drawer fronts



ASKERSUND
 Color/design: Dark brown ash wood effect
 Material: Melamine foil finish

ASKERSUND is a dark brown wood effect door with an equal blend of function and feeling. The melamine surface is easy to clean and withstands moisture and bumps, while the wood pattern both looks and feels natural and vibrant. Complement with JUTIS glass door.

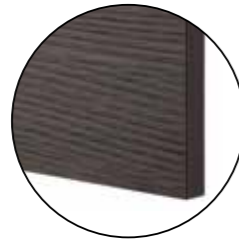

ASKERSUND
 Color/design: Light ash wood effect
 Material: Melamine foil finish

ASKERSUND is a blonde ash wood effect door, with a grain pattern that you can see and feel. It creates a light, modern kitchen. Complement with JUTIS accent door.



Framed doors and drawer fronts



AXSTAD
 Color/design: Matte white
 Material: Foil finish

AXSTAD door has a matte, white surface with soft lines and a recessed center panel. The design allows you to use it to create both a modern and traditional kitchen. Complement with AXSTAD tempered glass doors.



AXSTAD
 Color/design: Matte gray
 Material: Foil finish

AXSTAD door has a matte, gray surface with soft lines and a recessed center panel. The design allows you to use it to create both a modern and traditional kitchen. Complement with AXSTAD tempered glass doors.



KUNGSBACKA
 Color/design: Anthracite
 Material: Recycled PET foil

KUNGSBACKA anthracite is a door with a striking matte black finish and two chamfered edges. It's made from recycled wood and PET bottles and brings a modern, streamlined look to your kitchen. Complement with JUTIS accent door.



BODARP
 Color/design: Gray-green
 Material: Foil finish

BODARP is a door with sleek, straight lines and brings a colorful, modern look to your kitchen. Complement with JUTIS accent door.

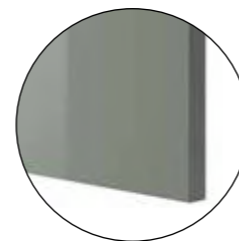

AXSTAD
 Color/design: Matte blue
 Material: Foil finish

AXSTAD door has a matte, blue surface with soft lines and a recessed center panel. The design allows you to use it to create both a modern and traditional kitchen. Complement with AXSTAD tempered glass doors.



Framed doors and drawer fronts



BODBYN
Color/design: Off-white
Material: Painted finish

Rich in detail, BODBYN off-white door has a panel that is bevelled on the inside and contoured on the outside. It gives your kitchen a traditional touch. Complement with BODBYN tempered glass doors.



BODBYN
Color/design: Gray
Material: Painted finish

Rich in detail, BODBYN gray door has a panel that is bevelled on the inside and contoured on the outside. It gives your kitchen a traditional touch. Complement with BODBYN tempered glass doors.



BODBYN
Color/design: Dark green
Material: Painted finish

Rich in detail, BODBYN dark green doors has a panel that is bevelled on the inside and contoured on the outside. It gives your kitchen a traditional touch. Complete with BODBYN tempered glass doors.



STENSUND
Color/design: Beige
Material: Painted finish

STENSUND offers a touch of country living with framed fronts and grooved panels that create a warm, crafted look. The lacquered surface resists stain and moisture and wipes clean in an instant.



Framed doors and drawer fronts



New

ENKÖPING
Color/design: White wood effect
Material: Foil finish

ENKÖPING has a classic look in white that feels inviting and will outlast the test of time. ENKÖPING framed fronts are covered in durable foil with a subtle grain structure that gives an authentic, warm wood character.

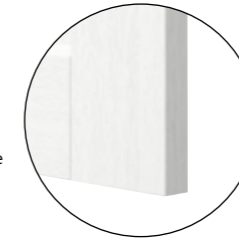

New

ENKÖPING
Color/design: Brown walnut effect
Material: Foil finish

ENKÖPING has a classic look in brown walnut that feels inviting and will outlast the test of time. ENKÖPING framed fronts are covered in durable foil with subtle grain structure that gives an authentic wood character.



LERHYTTAN
Color/design: Black stained
Material: Stained ash veneer and solid ash

LERHYTTAN door has a distinct traditional character, with a solid wood frame, bevelled edges and a recessed veneer center panel. LERHYTTAN creates a cozy kitchen with rustic charm. Complement with LERHYTTAN tempered glass doors.



New

VEDHAMN
Color/design: Oak
Material: Solid oak

VEDHAMN kitchen fronts in natural warm wood welcome you and make you feel right at home. The solid oak frame doors with oak veneer panels offer a beautiful, robust construction with attention to detail.



Framed doors and drawer fronts



LERHYTTAN

Color/design: Light gray
Material: Clear lacquered solid birch

LERHYTTAN door has a distinct traditional character, with a solid wood frame with bevelled edges and an inset veneer panel. It gives you a cozy kitchen with rustic charm. Complement with LERHYTTAN tempered glass doors.



High-gloss doors and drawer fronts



RINGHULT

Color/design: High-gloss white
Material: High-gloss foil finish

RINGHULT white doors have sleek, straight lines and a high-gloss surface that's durable and easy to clean. RINGHULT brings a bright, modern look to your kitchen. Complement with JUTIS glass door.



Doors and drawer fronts with integrated handles



VOXTORP

Color/design: Walnut effect
Material: Particleboard and foil finish

VOXTORP is a smooth door with integrated handles. It brings clean lines and an open, modern look to your kitchen. Complement with JUTIS glass door.



Doors and drawer fronts with integrated handles



VOXTORP

Color/design: Matte white
Material: Foil finish

VOXTORP is a smooth, matte door with integrated handles. It brings clean lines and an open, modern look to your kitchen. Complement with JUTIS glass door.



VOXTORP

Color/design: Dark gray
Material: Foil finish

VOXTORP is a smooth door with integrated handles. It brings clean lines and an open, modern look to your kitchen. Complement with JUTIS glass door.

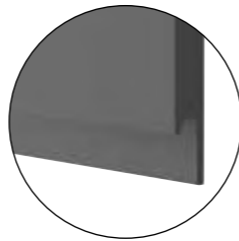

Accent doors

Accent doors are a great way to get a more personal look by adding a contrast, a pattern or a splash of color.

They're designed to complement the other doors in your kitchen, which means they don't come in as many sizes as other fronts.

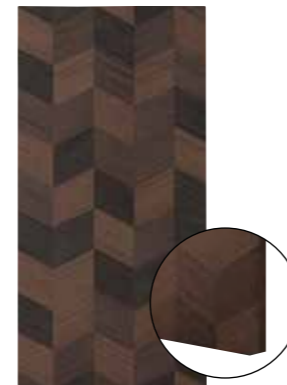

HASSLARP

Color/design: Brown, right-handed pattern
Material: Particleboard, poplar and oak veneer

HASSLARP has a herringbone patterned oak veneer with characteristic details that give your kitchen a unique accent. Designed to match the SINARP series, but can also be paired with solid-colored doors for a modern look.

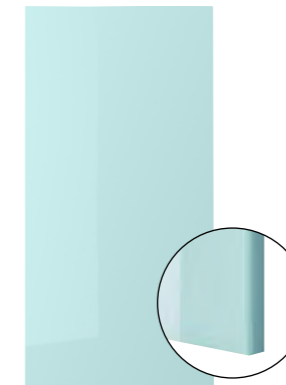

JÄRSTA

Color/design: High-gloss light turquoise
Material: Particleboard with foil finish

JÄRSTA high-gloss accent door in a striking light turquoise finish adds a lot of attitude and a highly personal touch to your kitchen.

JUTIS Glass doors

JUTIS glass doors are very versatile fronts that blend perfectly with many of our other kitchen doors and drawer fronts. Handles are included.



JUTIS

Color/design: Frosted glass and aluminum or smoked glass and black

Material: Tempered glass and aluminum

JUTIS white or smoked glass doors are versatile and blend perfectly with all our other kitchen fronts. A perfect option if you've chosen a family of fronts with no glass doors. Handles included.

Frosted glass and aluminum

W15×H30"	202.666.35
W15×H40"	702.666.33
W18×H30"	002.666.36
W18×H40"	902.666.32

Smoked glass and black

W15×H30"	202.666.40
W15×H40"	602.666.43
W18×H30"	402.666.39
W18×H40"	802.666.42

Accent drawer fronts

Using drawer fronts in a different material is a great way to add a personal touch to your kitchen. FRÖJERED bamboo accent drawer fronts can add a touch of warmth to your kitchen.

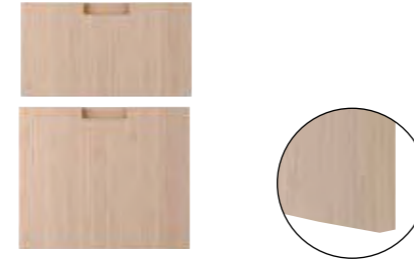

FRÖJERED Drawer front

Color/design: Light bamboo

Material: Bamboo

W18×H10"	004.416.35
W18×H15"	804.416.36
W24×H10"	604.416.37
W24×H15"	404.416.38
W30×H10"	204.416.39
W30×H15"	804.416.41

Cover panels, decorative moldings, toekicks and legs

Add the finishing touches

Whether you've decided to go for a more traditional style with lots of drawers and decorative elements, or a sleek modern, more minimalistic style, there are still finishing touches for you to add to make your kitchen stunning.

Enhance your style with uniform cover panels, decorative moldings, legs and toekicks. Or, you can be a bit bold and go for a finish that contrasts with your doors and drawers. It's all up to you.



Decorative toekick



Cover panel



Decorative molding

Cover panels

Choose a cover panel in the same finish as your door for a uniform expression, or mix and match to suit your taste.

ASKERSUND Cover panel Light ash wood effect



W15×H32½"	403.483.48
W15×H42½"	203.483.49
W15×H90"	003.483.50
W25×H30"	803.483.51
W25×H80"	603.483.52
W25×H90"	403.483.53
W26×H36"	203.483.54
W36×H96"	803.483.94

HAVSTORP Cover panel Beige



W15×H32½"	104.752.86
W15×H42½"	904.752.87
W15×H90"	704.752.88
W25×H30"	504.752.89
W25×H80"	304.752.90
W25×H90"	104.752.91
W26×H36"	904.752.92
W36×H96"	704.752.93

STENSUND Cover panel Beige



W15×H31½"	404.676.85
W15×H41½"	804.532.57
W15×H90"	604.532.58
W25×H30"	404.532.59
W25×H80"	704.046.77
W25×H90"	004.532.61
W26×H36"	804.532.62
W36×H96"	604.532.63

VOXTORP Cover panel Walnut effect



W15×H32½"	103.281.01
W15×H42½"	903.281.02
W15×H90"	703.281.03
W25×H30"	503.281.04
W25×H80"	203.281.05
W25×H90"	003.281.06
W26×H36"	803.281.07
W36×H96"	603.281.08

ASKERSUND Cover panel Dark brown ash wood effect

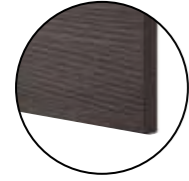

W15×H32½"	904.250.61
W15×H42½"	704.250.62
W15×H90"	504.250.63
W25×H30"	304.250.64
W25×H80"	004.250.65
W25×H90"	804.250.66
W26×H36"	604.250.67
W36×H96"	404.250.68

HAVSTORP Cover panel Turquoise

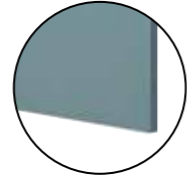

W15×H32½"	404.755.05
W15×H42½"	204.755.06
W15×H90"	004.755.07
W25×H30"	804.755.08
W25×H80"	604.755.09
W25×H90"	404.755.10
W26×H36"	204.755.11
W36×H96"	004.755.12

ENKOPING Cover panel White wood



New

W15×H31½"	205.059.28
W15×H41½"	005.059.29
W15×H90"	805.059.30
W25×H30"	605.059.31
W25×H80"	405.059.32
W25×H90"	205.059.33
W26×H36"	005.059.34
W36×H96"	705.059.35

ENKOPING Cover panel Brown walnut



New

W15×H31½"	305.167.09
W15×H41½"	105.167.10
W15×H90"	905.167.11
W25×H30"	705.167.12
W25×H80"	505.167.13
W25×H90"	305.167.14
W26×H36"	005.167.15
W36×H96"	805.167.16

AXSTAD Cover panel Matte blue

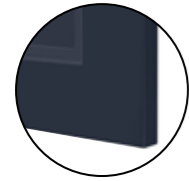

W15×H32½"	904.683.95
W15×H42½"	504.683.97
W15×H90"	304.683.98
W25×H30"	004.683.90
W25×H80"	604.683.92
W25×H90"	104.683.99
W26×H36"	204.683.94
W36×H96"	704.683.96

KUNGSBACKA Cover panel Anthracite

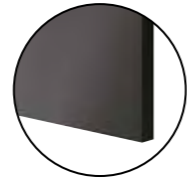

W15×H31"	603.379.09
W15×H41"	203.379.11
W15×H90"	003.379.12
W25×H30"	803.379.13
W25×H80"	603.379.14
W25×H90"	303.379.15
W26×H36"	103.379.16
W36×H96"	903.379.17

VEDHAMN Cover panel Oak



New

W15×H31½"	805.051.38
W15×H41½"	605.051.39
W15×H90"	405.051.40
W25×H30"	205.051.41
W25×H80"	005.051.42
W25×H90"	605.051.44
W26×H36"	305.051.45
W36×H96"	105.051.46

FRÖJERED Cover panel Light bamboo



W15½×H30"	604.416.23
W25×H30"	404.416.24

BODARP Cover panel Gray-green

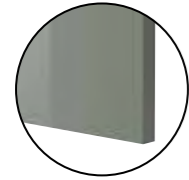

W15×H32½"	104.355.92
W15×H42½"	904.355.93
W15×H90"	704.355.94
W25×H30"	404.355.95
W25×H80"	204.355.96
W25×H90"	004.355.97
W26×H36"	804.355.98
W36×H96"	604.355.99

LERHYTTAN Cover panel Stained black



W15×H32½"	803.559.21
W15×H42½"	603.559.22
W15×H90"	403.559.23
W25×H30"	203.559.24
W25×H80"	903.559.25
W25×H90"	703.559.26
W26×H36"	503.559.27
W36×H96"	303.559.28

BODBYN Cover panel Gray

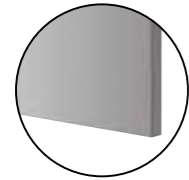

W15×H32½"	402.660.26
W15×H42½"	002.660.28
W15×H90"	202.660.27
W25×H30"	802.660.53
W25×H80"	102.660.23
W25×H90"	602.660.54
W26×H36"	902.660.24
W36×H96"	602.660.25

LERHYTTAN Cover panel Light gray



W15×H31¼"	803.532.34
W15×H41½"	503.532.35
W15×H90"	303.532.36
W25×H30"	103.532.37
W25×H80"	903.532.38
W25×H90"	703.532.39
W26×H36"	503.532.40
W36×H96"	303.532.41

BODBYN Cover panel Dark green

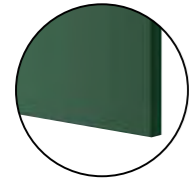

W15×H32½"	004.451.72
W15×H42½"	804.451.73
W15×H90"	604.451.74
W25×H30"	304.451.75
W25×H80"	104.451.76
W25×H90"	904.451.77
W26×H36"	704.451.78
W36×H96"	504.451.79

SINARP Cover panel Brown



W15×H32½"	604.046.73
W15×H42½"	404.046.74
W15×H90"	104.046.75
W25×H30"	904.046.76
W25×H80"	704.046.77
W25×H90"	504.046.78
W26×H36"	304.046.79
W36×H96"	104.046.80

FÖRBÄTTRA Cover panels

Our FÖRBÄTTRA cover panels are developed to fit all our various white doors and drawer fronts. Choose a FÖRBÄTTRA in the same color and finish as your door for a perfect match.

FÖRBÄTTRA Cover panel Off-white



W15×H32½"	602.664.07
W15×H42½"	402.664.08
W15×H90"	202.664.09
W25×H30"	802.664.11
W25×H80"	402.664.13
W25×H90"	202.664.14
W26×H36"	602.664.12
W36×H96"	902.664.15

FÖRBÄTTRA Cover panel White



W15×H32½"	302.664.37
W15×H42½"	102.664.38
W15×H90"	902.664.39
W25×H30"	702.664.40
W25×H80"	302.664.42
W25×H90"	102.664.43
W26×H36"	502.664.41
W36×H96"	902.664.44

FÖRBÄTTRA Cover panel Dark gray

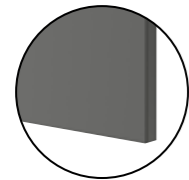

W15×H32½"	804.561.28
W15×H42½"	604.561.29
W15×H90"	404.561.30
W25×H30"	204.561.31
W25×H80"	004.561.32
W25×H90"	804.561.33
W26×H36"	604.561.34
W36×H96"	304.561.35

FÖRBÄTTRA Cover panel High-gloss white

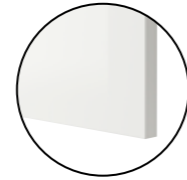

W15×H32½"	904.002.87
W15×H42½"	704.002.88
W15×H90"	504.002.89
W25×H30"	304.002.90
W25×H80"	104.002.91
W25×H90"	904.002.92
W26×H36"	704.002.93
W36×H96"	504.002.94

FÖRBÄTTRA Cover panel Matte white

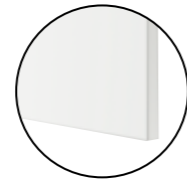

W15×H32½"	504.177.46
W15×H42½"	304.177.47
W15×H90"	104.177.48
W25×H30"	904.177.49
W25×H80"	704.177.50
W25×H90"	504.177.51
W26×H36"	304.177.52
W36×H96"	104.177.53

Decorative moldings

Decorative moldings provides the finishing touch to your kitchen. They come in many different styles, but we have something for all of our door and drawer families. Use them to tie your style together, hide lighting or just as a decorative element.

You can choose how to mount them on your cabinets. Below we show the entire range and some different ways of mounting them, both above as moldings and below your cabinet, either wrapped around the whole cabinet or just between your cover panels.

ASKERSUND Decorative molding rounded

Light ash wood effect

87×2¾" 803.318.50



ASKERSUND Decorative molding rounded

Dark brown ash wood effect

87×2¾" 704.252.36



AXSTAD Decorative molding rounded

Matte blue

87×2¾" 304.752.47



BODARP Decorative molding rounded

Gray-green

87×2¾" 704.355.27



BODBYN Decorative molding contoured

Gray

87×2¾" 602.210.65



BODBYN Decorative molding contoured

Dark green

87×2¾" 404.445.14



BODBYN Decorative molding contoured

Off-white

87×2¾" 804.177.59



Decorative moldings

HAVSTORP Decorative molding rounded
Beige

87×2¾" 604.752.55



HAVSTORP Decorative molding rounded
Turquoise

87×2¾" 404.754.35



KUNGSBACKA Decorative molding chamfered
Anthracite

87×1½" 903.373.28



LERHYTTAN Decorative molding contoured
Stained black

87×1¾" 903.560.91



LERHYTTAN Decorative molding contoured
Light gray

87×1¾" 903.523.71



SINARP Decorative molding rounded
Brown

87×2¾" 104.041.47



STENSUND Decorative molding contoured
Beige

87×1½" 304.531.70



ENKOPING Decorative molding contoured
White wood

87×1½" 805.057.51



ENKOPING Decorative molding contoured
Brown walnut

87×1½" 705.165.66



VEDHAMN Decorative molding contoured
Oak

87×1½" 205.003.70



FÖRBÄTTRA Decorative moldings

Our FÖRBÄTTRA decorative moldings are developed to fit all our various white doors and drawer fronts. Choose a FÖRBÄTTRA in the same color and finish as your door for a perfect match.

FÖRBÄTTRA Decorative molding, rounded Off-white

87×2¾" 702.069.60



FÖRBÄTTRA Decorative molding, rounded White

87×2¾" 202.978.87



FÖRBÄTTRA Decorative molding, rounded High-gloss white

87×2¾" 503.974.80



FÖRBÄTTRA Decorative molding, rounded Matte white

87×2¾" 704.176.65



FÖRBÄTTRA Decorative molding, rounded Dark gray

87×2¾" 504.540.84



Toekicks and legs

Choose between a regular or a decorative toekick to cover the gap between your cabinet and the floor. As an alternative to a toekick you can also choose to put legs on your base and high cabinets.

BODBYN Gray



Standard toekick 84×4½"

002.660.52

Decorative toekick 87×4½"

202.786.76

Decorative toekick with cut out
26¾×4½"

402.930.82

Legs H4½"

802.786.78 2pk

BODBYN Dark green



Standard toekick 84×4½"

204.452.27

Decorative toekick 87×4½"

304.451.80

Decorative toekick with cut out
26¾×4½"

104.451.81

Legs H4½"

404.452.26 2pk

LERHYTTAN Stained black

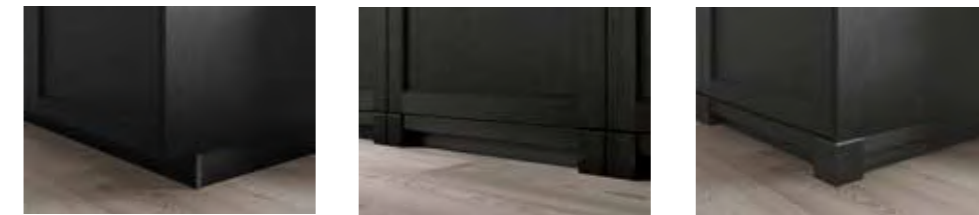

Standard toekick 84×4½"

303.559.71

Legs for decorative toekick

703.978.13 2pk

Corner legs for decorative toekick

804.032.29 2pk

LERHYTTAN Light gray



Standard toekick 84×4½"

604.825.43

Legs for decorative toekick

503.978.14 2pk

Corner legs for decorative toekick

004.032.33 2pk

Standard toekicks

ASKERSUND
Light ash wood effect



Toekick 84×4½"

003.483.93

ASKERSUND
Dark brown ash wood effect

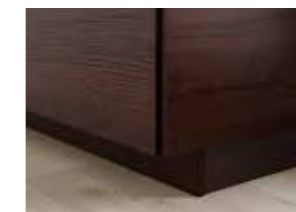

Toekick 84×4½"

804.251.08

AXSTAD
Matte blue



Toekick 84×4½"

504.684.01

BODARP
Gray-green



Toekick 84×4½"

204.356.38

Toekicks and legs

Standard toekicks

HAVSTORP Beige



Toekick 84×4½"
204.752.95

KUNGSBACKA Anthracite



Toekick 84×4½"
503.379.57

SINARP Brown



Toekick 84×4½"
704.047.24

ENKOPING Brown walnut



New

Toekick 84×4½"
305.059.80

STENSUND Beige



Toekick 84×4½"
304.533.30

TORHAMN Natural ash



Toekick 84×4½"
003.135.29

VOXTORP Walnut effect



Toekick 84×4½"
303.281.43

VEDHAMN Oak



New

Toekick 84×4½"
305.051.88



SEKTION Legs H3½-5½".

May be completed with toekick.

102.655.18

4pk



CAPITA Legs H4-5".

Stainless steel

602.635.74

4pk

White

302.635.75

4pk

FÖRBÄTTRA Toekicks and legs

Our FÖRBÄTTRA toekicks and legs are developed to fit all our various white doors and drawer fronts. Choose a FÖRBÄTTRA in the same white color and finish as your door for a perfect match.

FÖRBÄTTRA Off-white



Standard toekick 84×4½"

402.875.90



Decorative toekick 87×4½"

002.786.77



Decorative toekick with cut out
26¾×4½"

702.930.85



Legs 4½"

402.786.75 **2pk**

FÖRBÄTTRA White



Standard toekick 84×4½"

602.668.17

FÖRBÄTTRA High-gloss white



Standard toekick 84×4½"

204.002.95

FÖRBÄTTRA Matte white



Standard toekick 84×4½"

904.177.54

FÖRBÄTTRA Dark gray



Standard toekick 84×4½"

704.561.81



FÖRBÄTTRA
Decorative toekick
Off-white
002.786.77

Lighting and sound

A brighter kitchen life

Good lighting is an essential part of any kitchen. That's why we offer integrated lighting products perfectly dimensioned to fit our kitchen cabinets. And they all contain long-lasting built-in LEDs which consume up to 85% less energy, produce much less heat and last up to 20 times longer than incandescent bulbs. Having IKEA integrated lighting installed in your kitchen is a great way to light your beautiful new countertops and pour light onto everyday tasks in the kitchen, as well as to show off your favorite dinnerware behind glass doors or to brighten up your utensils, spices, bowls and cookware in your drawers!

Planning and installing integrated lighting in your new kitchen is an investment you will enjoy for many, many years! Everyone agrees that great countertop lighting is a must for every successful kitchen. Adding lighting to your glass door cabinets is a great way to show off your most prized treasures, while also adding a wonderful sparkle to your space. And it may seem like a 'nice-to-have' at first, but when your integrated drawer lighting illuminates the instant you open a drawer, you'll agree it's a must-have that you deserve and will come to love! **Pre-planning is the key for easiest installation.

Get an even better kitchen experience with the ability to dim, turn off and turn on lights wirelessly. All you need is TRÅDFRI LED driver and STYRBAR remote control. Or use the TRÅDFRI gateway and Home smart app to control every beam of light with your smart phone. We call it IKEA Smart lighting.



KITCHEN INSTALLATION

If you want we can install all your kitchen lighting for you, as a part of our Kitchen Installation service. See more on [page 7](#).



Drawer lighting simplifies finding what you need even during those midnight kitchen raids. Opening and closing the drawer turns the light on and off automatically.



SYMFONISK speaker hung on kitchen rail, saving precious space on your countertop while providing all of the audio you love.



Countertop lighting should give you a clean, clear view of all the work you're doing in the kitchen.



Spotlights provide a focused light that is good for lighting smaller areas and behind glass doors.



Cabinet lighting illuminates your favorite kitchen doors and creates a cozy mood light in the entire kitchen.

MITTLED series

MITTLED has a compact design for both under cabinets and inside drawers. And **hardwiring is not necessary**

Countertop lighting



when installed with TRÅDFRI LED driver(s) and ANSLUTA power supply cord.



MITTLED LED dimmable countertop lighting Matches your cabinet sizes and features a compact design. LED life time approx. 25,000 hrs. Lamps are able to connect together for a seamless look and even task lighting across a run of connected wall cabinets. Lights are dimmable with TRÅDFRI LED driver, TRÅDFRI dimmer, and TRÅDFRI gateway, sold separately.
Note: The VAGDAL connection cord is not included with MITTLED countertop lights, it must be purchased separately according to the number of connected lights you are using.

Only one VAGDAL connection cord is required per group of MITTLED countertop lights connected together. If installing a single MITTLED countertop light, one VAGDAL connection cord is needed for that unit. If connecting 3 MITTLED lights, 1 VAGDAL cord is needed.

The VAGDAL connection cords then connect to TRÅDFRI LED driver(s). The LED driver then connects to an electrical outlet using an ANSLUTA power supply cord, all sold separately.

White	L12", 3.3W	904.725.14
	L15", 4.3W	104.554.34
	L18", 5W	504.554.27
	L24", 6W	004.554.20

Purchase VAGDAL connection cord separately for each group of lights.

	VAGDAL Connection cord	
	137¾"	704.636.00



MITTLED LED lighting strip for drawers In an IKEA kitchen you can have lighting inside all your drawers. Opening and closing the drawer turns the light on and off automatically. Must be completed with an LED driver. For drawer lighting, it is best to use a dedicated driver not connected to other lighting. Use either a TRÅDFRI driver coupled with ANSLUTA power supply cord or an ANSLUTA LED driver which already includes the power cord. All sold separately.

Why a dedicated driver? Drawer lighting must stay in an 'on' position so that the MITTLED lights on/off sensors operate properly. A dedicated LED driver for drawer lighting ensures there is no interference by other smart devices connected to TRÅDFRI drivers, such as dimmers, remote controls or gateway wireless controls.

White	L14", 2W	404.635.26
	L17", 2W	504.720.40
	L23", 2W	604.635.54
	L29", 3.5W	204.635.70
	L34", 3.5W	304.720.41



MITTLED LED spotlight Interior cabinet lighting enhances the atmosphere and gives a good overview of things inside your glass door cabinets. Dimmable with TRÅDFRI LED driver, dimmer and ANSLUTA power supply cord, sold separately. Can be installed in its housing or integrated into coving. Ø2¾".

White	2.2W	404.536.45
Black	2.2W	504.721.39
Aluminum	2.2W	304.536.55

Drawer lighting



Cabinet lighting



Cabinet lighting



Cabinet lighting illuminates your favorite kitchen doors and creates a cozy mood light in the entire kitchen. LINDSHULT cabinet lighting includes energy saving LED and can be dimmed with TRÅDFRI LED driver, gateway and dimmer.



LINDSHULT LED cabinet lighting Provides a focused light that is good for lighting smaller areas. To be completed with LED driver and ANSLUTA power supply cord, sold separately. Dimmable with TRÅDFRI dimmer or STYRBAR remote control, sold separately.

Nickel-plated	1.5W	302.604.40
---------------	------	------------



YTBORG Cabinet lighting The lamp's slim and neat design goes with most styles and is perfect if space is limited between the top of your cabinet and the ceiling. You can easily direct the light where you like since the arm can be bent 180° and the lamp head angled 90°. You can turn up to 6 light sources on and off simultaneously if you complete with ANSLUTA driver. If you also want to be able to dim, choose TRÅDFRI driver and wireless dimmer instead. Sold separately.

Black	2W	105.278.98
White	2W	505.168.31



TVÄRDRA Cabinet lighting A lovely traditional cabinet lamp. The metal shade creates a direct light that illuminates your cabinets. If you want the lamp's light to be directed into your display cabinet, just angle the lamp head inwards. You can turn up to 6 light sources on and off simultaneously if you complete with ANSLUTA driver. If you also want to be able to dim, choose TRÅDFRI driver and STYRBAR remote control instead, sold separately.

Black	1.5W	405.168.41
-------	------	------------

SKYDRAG Countertop lighting series



SKYDRAG LED countertop lighting with sensor Must be completed with TRÅDFRI LED driver and ANSLUTA power supply cord, sold separately. You can connect as many LED light strips as you like, as long as the total wattage of the products does not exceed the maximum wattage of the connected driver(s). Add the TRÅDFRI gateway and IKEA Home smart app for wireless control through Amazon Alexa, Apple HomeKit or Google Home. Dimmable with TRÅDFRI wireless dimmer, sold separately.

L12"		
White	3W	004.791.62
L18"		
White	4W	004.395.95
Black	4W	904.396.09
L24"		
White	6W	404.396.02
Anthracite	6W	104.791.66

SKYDRAG LED lighting is dimmable and long lasting. Lighting creates atmosphere in homes and makes everyday life easier. This LED worktop lighting has been specially designed for ENHET kitchen series, but is of course just as easy to install in an existing kitchen or also works great in AURDAL and BOAXEL wardrobe systems!

SYMFONISK series



SYMFONISK WiFi bookshelf speaker Place the speaker horizontally or vertically, or mount it on the wall to use as a practical shelf. Also helps you to use your space optimally, while providing a rich sound that fills the entire room. SYMFONISK WiFi speaker allows you to stream music, radio, and podcasts from your network and streaming services. Supports all of the major music streaming subscription services. You control the speaker with the Sonos app. Works with IKEA Home smart app. 4x6x12".

Black/gen 2	205.065.84
White/gen2	405.065.97

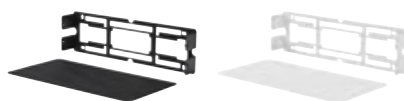

SYMFONISK Bookshelf speaker wall bracket Hang SYMFONISK WiFi bookshelf speaker on the wall to save space at home. With this wall bracket you can easily mount the speaker on the wall — and with the included silicone mat you can use it as a practical shelf. Max load 6.5 lbs depending on type of wall and fastening.

Black	104.381.71
White	104.609.30



SYMFONISK Speaker hooks Hang SYMFONISK WiFi bookshelf speaker on the wall to save space in your kitchen. With this speaker hook you can easily hang it on a rail like KUNGSFORS or FINTORP — saving precious space on your countertop.

Black	504.443.25	2pk
-------	------------	------------

TRÅDFRI and ANSLUTA series



With the TRÅDFRI gateway you can control all your TRÅDFRI driver connected lighting via the IKEA Home Smart app or your voice assistant. Create moods and set scenes together with other IKEA Smart lighting.

All non-battery operated lighting requires use of a transformer (LED driver) to operate. Light sources plug into an LED driver. The LED driver connects to an electrical outlet by way of either ANSLUTA power supply cord for “smart” set up, or ANSLUTA LED driver with power cord and switch for manual operation.

- For wireless or “smart” functionality, pair a **TRÅDFRI LED driver** and **ANSLUTA power supply cord**, sold separately.
- For basic on/off manual functionality, use the singular IKEA product **ANSLUTA LED driver with power cord**, sold separately.



New

STYRBAR Remote control With STYRBAR remote control you can dim your TRÅDFRI connected lighting without a wired installation. A magnet makes it easy to attach the remote control to the wall bracket. Requires 2-AA batteries. IKEA recommends our sustainable LADDA rechargeable batteries. Batteries are sold separately. Works with IKEA Home smart.

White	804.883.70
Stainless steel	504.636.15



TRÅDFRI Gateway With TRÅDFRI gateway and app you can control each light source individually, create different types of lighting settings — and control them with the TRÅDFRI Home smart app or personal assistant via Apple HomeKit, Amazon Alexa or Google Home.

White	003.378.13
-------	------------



TRÅDFRI LED driver To be completed with ANSLUTA power supply cord, sold separately. These drivers will pair with TRÅDFRI dimmer and STYRBAR remote control for wireless operation. You can connect up to 10 TRÅDFRI LED drivers in one installation.

Up to 10W	103.561.89
Up to 3 light units per driver, 10W max	
Up to 30W	603.426.61
Up to 9 light units per driver, 30W max	



TRÅDFRI Wireless dimmer You can add up to 10 light sources and mix LED bulbs, so that they all switch on, off or are dimmed at the same time, or use multiple dimmers to control separate areas of the space.

White	104.085.98
-------	------------



ANSLUTA Power supply cord For connecting your TRÅDFRI LED driver or multiple drivers to house power outlet. Press the cord switch for manual operations such as turning them all on and off simultaneously. Or for “smart” operations, pair your TRÅDFRI LED driver with TRÅDFRI dimmer or STYRBAR remote control. Add the TRÅDFRI gateway and manage operations using the IKEA Home smart app. White.

L11'6"	301.214.11
--------	------------



ANSLUTA Intermediate connection cord Allows you to connect several LED drivers together with only one connection to the main power outlet. White.

L28"	401.199.26
L79"	601.199.25



ANSLUTA LED driver with power cord 19W. Now you don't need to walk around at home to turn your lamps on and off. With ANSLUTA driver with power cord, you connect up to 6 light sources, plug it into your outlet, and control all lights simultaneously with a single power switch. White

19W max load	904.058.45
--------------	------------

Countertops

Your kitchen is the heart of your home, it's a room for everyone! How it performs and how it looks are two important factors. Even though doors and drawer fronts are the main style decision you make when updating your kitchen, your countertop can have a big impact on the overall look. However, the perfect countertop is not just about completing the look of your kitchen, it has an impact on its functionality too. When picking the right countertop there are many factors to consider, including your style, durability, maintenance, lifestyle and cost. Our countertops are available in pre-cut and custom-made as well as in durable materials, finishes and thicknesses. Each surface has unique properties, with differing levels of water, wear and heat resistance.

How to choose your countertop:

1

What's your budget?
A stylish look does not have to cost a fortune, our countertops are available in wide range of materials and expressions, pre-cut as well as custom-made to perfectly fit your style, needs and wallet.

2

What kind of material do you prefer? When deciding on material, consider how robust you need your countertop to be, how much you are prepared to look after it, and how you want it to look in your kitchen environment.

3

Custom-made countertops are made-to-fit your kitchen layout, you can order the exact size you need, as well as cut-outs for your sink, faucet and cooktop. Pre-cut countertops are available in different sizes, you can take them home today and cut to desired length.

Built to last

When we test our countertops we put them up against everything they'll face in your kitchen: liquids, oil, steam, heat, thumps, bumps and scratches. Once we're done we're so sure our countertops will last for many years to come.

25

Countertops have a free 25-year limited warranty. Exclusions apply. See pages 136-137 or [IKEA-USA.com/warranty](https://www.ikea.com/us/en/warranty) for details.



Materials

Laminate

Laminate countertops are durable, affordable and easy to maintain, with lots of colors and expressions to choose from. Spills and grease are easy to wipe clean and the countertop keeps its beauty over time, making it a practical solution.

Wood

















Countertops with a top layer of wood have all the qualities of solid wood, enhanced by modern technology. They are made with 1/8" layer of solid wood wrapped on particleboard. This increases the stability and makes them less likely to split or crack. They can be sanded down to remove minor scratches, and will keep their natural beauty over the years.

Quartz

Quartz is one of the hardest materials in nature, making the surface extremely durable and scratch resistant. Plus, the surface is smooth, non-porous and easy to keep clean.

Color overview

We offer pre-cut laminate countertops in two lengths. Choose between the many colors and expressions to find the perfect look. The laminate countertops can be cut into the length you need and finished with the edge strip included in the package.

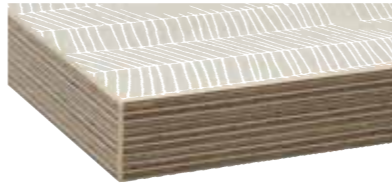
		
White	White marble effect	White with metal effect edge
		
White stone effect	Light gray with white edge	Gray with metal effect edge
		
Light gray stone effect	Light gray concrete effect	Concrete effect
		
Black stone effect	Black mineral effect	Ash effect
		
Light gray mineral effect	Aluminum effect with metal effect edge	Black marble effect
		
Dark gray/marble effect	Matte anthracite	Matte beige

Laminate countertops 1 1/8" thick



1 1/8" countertops create a light, contemporary feel and are often used in modern style kitchens.

 They are all available to take home today.



EKBACKEN Countertop
Dark gray marble effect

L74×D25%×H1 1/8"	703.971.77
L98×D25%×H1 1/8"	503.971.78
L74×D42×H1 1/8"	704.991.09



EKBACKEN Countertop
White marble effect

L74×D25%×H1 1/8"	403.356.28
L98×D25%×H1 1/8"	203.356.29
L74×D42×H1 1/8"	204.991.16



LILLTRÄSK Countertop
White

L50×D25%×H1 1/8"	505.160.15
L50×D34 1/2×H1 1/8"	305.160.16
L74×D25%×H1 1/8"	502.808.28
L98×D25%×H1 1/8"	302.808.29



EKBACKEN Countertop
Light gray concrete effect

L74×D25%×H1 1/8"	803.954.46
L98×D25%×H1 1/8"	603.954.47
L74×D42×H1 1/8"	504.991.10



EKBACKEN Countertop
Ash effect

L74×D25%×H1 1/8"	303.376.23
L98×D25%×H1 1/8"	103.376.24



EKBACKEN Countertop
Matte beige pattern

L74×D25%×H1 1/8"	403.971.93
L98×D25%×H1 1/8"	203.971.94



EKBACKEN Countertop
Concrete effect

L74×D25%×H1 1/2"	003.356.54
L98×D25%×H1 1/2"	703.356.55
L74×D42×H1 1/8"	404.991.20



EKBACKEN Countertop
Matte anthracite

L74×D25%×H1 1/8"	304.090.21
L98×D25%×H1 1/8"	104.090.22
L74×D42×H1 1/8"	904.991.08

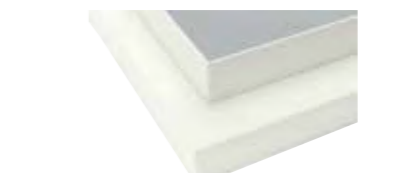

EKBACKEN Countertop
Double-sided, white with white edge/light gray with white edge

L74×D25%×H1 1/8"	002.913.39
L98×D25%×H1 1/8"	602.913.41



EKBACKEN Countertop
Brown walnut effect

L74×D25%×H1 1/8"	604.764.86
L98×D25%×H1 1/8"	004.429.89

Laminate countertops 1½" thick



A 1½" countertop creates a robust impression and can often be found in a traditional style kitchen.

 They are all available to take home today.

25

SÄLJAN Countertops have a free 25-year limited warranty. Find out more on [page 136](#).



SÄLJAN Countertop
Light gray mineral effect

L74×D25½×H1½" 803.972.09
L98×D25½×H1½" 403.972.11



SÄLJAN Countertop
White stone effect

L74×D25½×H1½" 102.766.11
L98×D25½×H1½" 902.766.12



SÄLJAN Countertop
Black mineral effect

L74×D25½×H1½" 602.749.83
L98×D25½×H1½" 102.749.85



SÄLJAN Countertop
Beige stone effect

L74×D25½×H1½" 804.391.34
L98×D25½×H1½" 504.391.35
L74×D42×H1½" 804.991.23



SÄLJAN Countertop
Oak effect

L74×D25½×H1½" 804.392.14
L98×D25½×H1½" 304.392.16
L74×D42×H1½" 004.991.22



SÄLJAN Countertop
Black marble effect

L74×D25½×H1½" 803.356.93
L98×D25½×H1½" 603.356.94



Small island/work bench

Create a simple island from a couple of open cabinets with a durable laminate countertop that can withstand all the baking and preparing you can handle.



Pre-cut thick veneer wood countertops



Natural and durable, wood brings a warm feeling to your kitchen and makes each countertop unique. It ages beautifully and you just sand and treat it to keep it looking great.

Pre-cut thick veneer wood countertops have a layer of solid wood covering a particleboard core. They feel and look the same as solid wood. With this technique we can create new unique expressions, using less wood and reducing the impact on the environment. We pre-treat them with a hard wax oil, so you don't have to oil them when you get them or treat them at all until the surface starts to wear. They're available to take home today.



Natural and durable, wood brings a warm feeling to your kitchen and makes each countertop unique. With thick veneer, a 1/8" layer of wood covers a particleboard core to add excellent stability.

Thick veneer countertops come in the following crafted patterns: full plank, butcher-block, fine line and chevron.

The countertops are pre-treated with hard wax oil to create an easy-care surface for immediate use. Over time, it will only look better, gaining in character. They can be sanded and treated when needed, meaning that they will age gracefully.

Thick veneer countertops are available in pre-cut sizes that you take home today. They can be cut into the exact length you need and finished with the edge strip included in the package.



Ash

Ash is a blonde hard wood with a beautiful grain pattern. Ash is a tough and strong, yet elastic material with great resilience and finishing properties. It gets gradually darker with age. In its natural form it is heavy and gives a very solid feel.



Birch

Birch is fine-grained and pale in color with a satin-like sheen that darkens with age. It often has knots or heartwood in cream or light brown, which will give your countertop a unique and distinct natural look.



Oak

Oak wood is exceedingly strong, heavy and durable. It is an attractive light color with a prominent grain. Its color ranges from light brown to a rich reddish-brown and it darkens beautifully with age.



Walnut

Walnut wood is relatively heavy, hard and resilient. The natural color light brown to dark chocolate brown adds warmth to your kitchen decor. Walnut gets lighter in color with age. It has a rich variation in color and a decorative, curved grain pattern.

Thick veneer wood countertops Walnut



The natural color and grain of wood adds warmth to your kitchen decor. Walnut gets lighter in color with age. It has a rich variation in color and a decorative, curved grain pattern.

They are all available to take home today.



BARKABODA Countertop
Thick veneer walnut

L74×D25%×H1½" 103.314.72
L98×D25%×H1½" 903.314.73



KARLBY Countertop
Thick veneer walnut

L74×D25%×H1½" 503.352.08
L98×D25%×H1½" 703.352.12
L74×D42×H1½" 302.976.41



PINNARP Countertop
Thick veneer walnut

L74×D25%×H1½" 004.674.75
L98×D25%×H1½" 204.674.79



EKBACKEN Countertop
Brown walnut effect/laminate

L74×D25%×H1½" 604.764.86
L98×D25%×H1½" 004.429.89

Thick veneer wood countertops Oak



Oak is a very hard wood, making it a popular choice for countertops and interiors. Its color ranges from light brown to a rich reddish-brown and it darkens with age.

They are all available to take home today.



KARLBY Countertop
Thick veneer oak

L74×D25%×H1½" 703.352.07
L98×D25%×H1½" 903.352.11
L74×D42×H1½" 502.976.40



MÖLLEKULLA Countertop
Thick veneer oak

L74×D25%×H1½" 003.011.35
L98×D25%×H1½" 803.011.36



SKOGSÅ Countertop
Thick veneer oak

L74×D25%×H1½" 203.829.94
L98×D25%×H1½" 903.829.95



VRENA Countertop
Thick veneer oak

L74×D25%×H1½" 304.371.56
L98×D25%×H1½" 004.371.53

Thick veneer wood countertops Birch



Birch is fine-grained and pale in color with a satin-like sheen that darkens with age. It often has knots or heartwood in cream or light brown, which will give your countertop a unique and distinct natural look.

They are all available to take home today.



KARLBY Countertop Thick veneer birch

L74×D25%×H1½" 903.352.06
L98×D25%×H1½" 103.352.10

Thick veneer wood countertops Ash



Ash is a blonde hard wood with a beautiful grain pattern. The variations in the color make each countertop unique and give it a distinctive natural look. It gets gradually darker with age.

They are all available to take home today.



PINNARP Countertop Thick veneer ash

L74×D25%×H1½" 703.723.13
L98×D25%×H1½" 503.723.14

Wood treatment oil



STOCKARYD Wood treatment oil
For indoor use.

17 oz 202.404.62

Big advantages of a custom-made countertop

Your custom-made countertop is made to fit your kitchen layout perfectly, with the least number of seams. You can order the exact length and depth you need for your kitchen island or bar solution as well as cut-outs for your sink, faucet and cooktop.



How to buy a custom-made countertop

1

Material and color

Choose a color that makes the kitchen your own.

2

The countertop profiles

Choose the desired profile for the edges. Depending on the material you've chosen for your countertop, you have different options.

3

Choose your sink

Choose the sink you want and if you want it top mounted or under-mounted.

4

Take measurements

Then start to measure to see what size and shape of countertop you need. If you would like help with this, or with anything to do with measuring your kitchen, our measuring service can come to your home.

5

We're here to help

To design your custom-made countertop get help from an IKEA co-worker in the kitchen department at your local store.

6

Order

To order your custom-made countertop, please contact an IKEA co-worker in the kitchen department at your local store.

How to measure your countertop

Start by measuring your countertop from the corner where it attaches to the wall. Make sure to make your measurements alongside the wall and always start from the same point. When measuring the depth, start from the wall and measure out. Don't forget to add 1½" for an overhang too.

If you need to measure for a freestanding countertop (for a kitchen island for example), simply start from one end and add 1½" extra for an overhang.

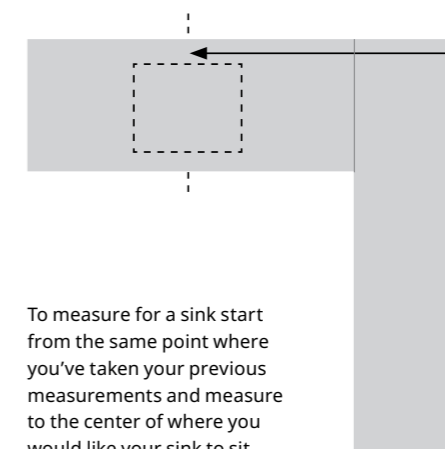
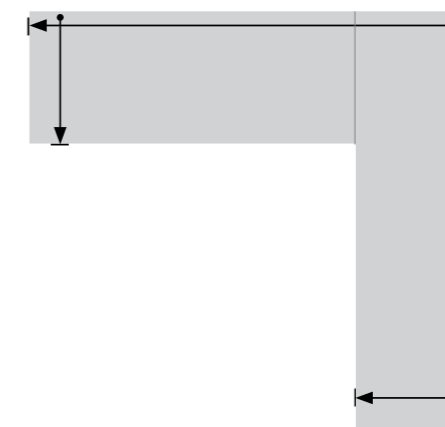

To measure for a sink start from the same point where you've taken your previous measurements and measure to the center of where you would like your sink to sit.

KASKER quartz custom-made countertops



When you choose a quartz countertop you get a work surface that's extremely durable. It's scratch resistant and can withstand heavy impact. We construct our quartz countertops with natural quartz crystals (one of the hardest materials in nature) and high-quality polymer resins which make the surface smooth, non-porous and easy to keep clean for even the busiest kitchen. You can also order quartz backsplashes to complement your countertop.

2cm thick quartz countertops are available in one edge style:

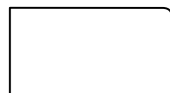

Straight



KASKER Countertop
White stone effect quartz

2cm thick 103.949.78

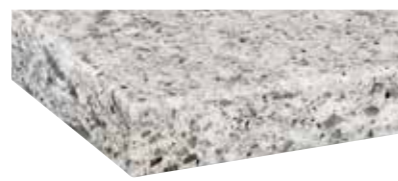

KASKER Countertop
Light gray /dark gray mineral effect quartz

2cm thick 005.294.16
3cm thick 803.949.89



KASKER Countertop
Black stone effect quartz

2cm thick 205.294.15
3cm thick 203.949.87



KASKER Countertop
White mineral effect quartz

2cm thick 505.294.14
3cm thick 303.950.00



KASKER Countertop
Matte light gray/concrete effect quartz

2cm thick 405.294.19
3cm thick 003.950.11



KASKER Countertop
White quartz

2cm thick 805.294.17
3cm thick 503.950.04

KASKER quartz custom-made countertops

3cm thick quartz countertops are available in five edge styles:

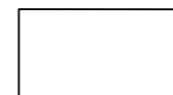

Straight

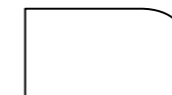

Half round

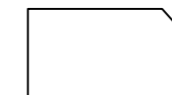

Beveled

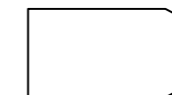

Chamfered



Full round



KASKER Countertop
Light gray/beige marble effect quartz

3cm thick 803.950.07



KASKER Countertop
Gray stone effect quartz

3cm thick 303.949.82



KASKER Countertop
Light gray/beige/glitter/marble effect quartz

3cm thick 504.237.66



KASKER Countertop
Gray marble

3cm thick 603.949.90



KASKER Countertop
Light gray stone effect quartz

3cm thick 003.949.93



KASKER Countertop
Off-white marble effect quartz

3cm thick 903.949.98



KASKER Countertop
Dark brown glitter/marble effect quartz

3cm thick 003.949.74



KASKER Countertop
White with mineral/glitter effect quartz

3cm thick 603.949.71

KASKER quartz custom-made countertops



KASKER Countertop
White stone/marble effect quartz
3cm thick 703.949.99



KASKER Countertop
Gray stone/marble effect quartz
3cm thick 903.949.79



KASKER Countertop
Black with mineral/glitter effect quartz
3cm thick 203.949.68



KASKER Countertop
Light gray marble effect quartz
3cm thick 603.950.13



KASKER Countertop
Black marble effect quartz
3cm thick 703.950.17



KASKER Countertop
Brown stone/marble effect quartz
3cm thick 403.950.14



KASKER Countertop
Dark gray marble effect quartz
3cm thick 903.950.16



KASKER Countertop
White marble effect quartz
3cm thick 103.950.01

Good to know

Clean using a soft cloth or sponge and warm water with a mild, non-abrasive detergent. Avoid using scouring products.

KASKER Quartz custom-made countertops

Support fitting for KASKER quartz countertops

To use KASKER in your kitchen you also need a support fitting that lifts the countertop up from the base cabinet frame, so that the countertop slides in place easily. Talk with a co-worker in the kitchen department to find out how many are needed for your countertop.



FIXA Countertop support fitting
Galvanized steel 702.746.28



Wall panels

Walls to match your style!

Adding wall panels is a quick and easy way to update your kitchen with new colors and texture. Our durable and easy-to-clean wall panels protect your walls from splashes and stains when you are cooking. They give you a neat finish where your countertop meets the wall and add a subtle accent of color to your kitchen walls creating a stylish look.

A stylish look does not have to cost a fortune, our wall panels are very affordable and available in a few colors and patterns. They are double sided and you can take them home today, quick and easy for a totally new look to your kitchen.



Our LYSEKIL wall panels are easy to install. You simply cut them to the right size and cement them to the wall.

For a perfect look, match with one of our pre-cut laminate countertops on page 44.

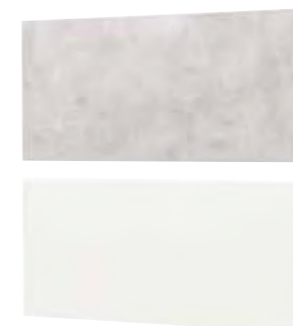

LYSEKIL Wall panel Double-sided white/light gray concrete effect

L48xH19" 704.287.01

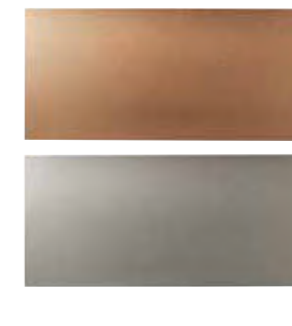

LYSEKIL Wall panel Double-sided brushed copper effect/stainless steel-color

L48xH19" 604.829.77



LYSEKIL Wall panel Double-sided, marble effect/black/white mosaic pattern

L48xH19" 904.644.58

Sinks

A busy place in the kitchen

The sink and the area around it is one of the busiest places in the kitchen. You use it for everything from preparing food and rinsing vegetables, to storing dirty dishes and cleaning up. To make the activities as easy as possible, choose a sink and sink accessories that match your needs and the way you work in the kitchen.

How to choose your sink

01

How much space have you allocated for the sink? Our sink cabinets are 24, 30 or 36" wide.

02

Think about how you prepare food, but also how you clean up. Do you have a dishwasher or do you wash the dishes by hand? Do you need one bowl, two bowls or a sink with drainboard?

03

Complete your sink with sink accessories that help you organize the area in and around the sink, both when you prepare food and when you clean up (**see page 116**).

25

We test our sinks to ensure they can withstand the demands of everyday life in the kitchen. That's why all our sinks come with a free 25-year limited warranty (except FYNDIG). Find out more on **pages 136-137**.



Our range of sinks

Single bowl sinks

If space is an issue, one single bowl is a good option. Plus, in a big single bowl you can easily wash large pots and pans. Combine with sink accessories to make the bowl as functional as possible (**see page 116**).

Double bowl sinks

Having two bowls is ideal if you have a lot going on at the same time. For example, if one of the bowls is piling up with dirty dishes, you can still rinse off vegetables and the like in the other.

1½ bowl sinks

A one and a half bowl sink gives you the same advantages as a double bowl sink, but in a smaller area.

Sinks with drainboard

A sink with a drainboard is ideal for drying dishes as the sloping surface make excess water flow back into the bowl. Our sink with drainboard is reversible, so you can choose if you want the drainboard to the left or to the right.

Fits 30" cabinets

**HILLESJÖN Inset sink, 1½-bowls**

Can be undermounted. May be completed with GRUNDVATTNET sink accessories for effective use of sink space. LILLVIKEN strainer is included but packaged separately. Requires installation. W22¾×D18½×H7¾".

Stainless steel 991.407.04

**KILSVIKEN Inset sink, 1-bowl**

Can be undermounted. The natural color variations of the quartz make each KILSVIKEN sink one of a kind bringing a unique look to your kitchen. The surface is durable and resistant to scratches, heat, stains and impacts. LILLVIKEN strainer and LILLVIKEN lid are included but packaged separately. Requires installation. W22×D18½×H7¾".

Quartz/acrylic black 393.370.15

**KILSVIKEN Inset sink, 1-bowl**

Can be undermounted. The natural color variations of the quartz make each KILSVIKEN sink one of a kind bringing a unique look to your kitchen. The surface is durable and resistant to scratches, heat, stains and impacts. LILLVIKEN strainer and LILLVIKEN lid are included but packaged separately. Requires installation. W28¾×D18½×H7¾".

Quartz/acrylic black 993.370.17

**KILSVIKEN Inset sink, 1-bowl**

Can be undermounted. The natural color variations of the quartz make each KILSVIKEN sink one of a kind bringing a unique look to your kitchen. The surface is durable and resistant to scratches, heat, stains and impacts. LILLVIKEN strainer and LILLVIKEN lid are included but packaged separately. Requires installation. W28¾×D18½×H7¾".

Dark brown/
quartz composite 793.370.23

**HILLESJÖN Inset sink, 1½-bowls**

Can be undermounted. May be completed with GRUNDVATTNET sink accessories for effective use of space of the sink. LILLVIKEN strainer is included but packaged separately. Requires installation. W29½×D18½×H7¾".

Stainless steel 091.407.08

**HILLESJÖN Inset sink, 2 bowls**

Can be undermounted. May be completed with GRUNDVATTNET sink accessories for effective use of space of the sink. LILLVIKEN strainer is included but packaged separately. Requires installation. W29½×D18½×H7¾".

Stainless steel 391.574.91

**LÅNGUDDEN Inset sink, 2-bowls**

Has a pre-drilled hole for a kitchen faucet. May be completed with GRUNDVATTNET sink accessories for effective use of space of the sink. LILLVIKEN strainer is included but packaged separately. Requires installation. W29½×D20¾×H7¾".

Stainless steel 991.574.88

**OLOFSJÖN Countertop with 1 integrated sink**

LILLVIKEN strainer and LILLVIKEN lid are included but packaged separately. Requires installation. 47¼×25".

Stainless steel 693.935.33

**OLOFSJÖN Countertop with 2 integrated sinks**

LILLVIKEN strainer and LILLVIKEN lid are included but packaged separately. Requires installation. 55¾×25".

Stainless steel 193.935.35

Countertop with integrated sink

Fits 36" cabinets

**NORRSJÖN Inset sink, 1-bowl**

Can be undermounted. May be completed with NORRSJÖN sink accessories for effective use of space of the sink. LILLVIKEN strainer and LILLVIKEN lid are included but packaged separately. Requires installation. W28¾×D17¼×H7¾".

Stainless steel 491.579.14

**NORRSJÖN Inset sink, 2-bowls**

Can be undermounted. May be completed with NORRSJÖN sink accessories for effective use of space of the sink. LILLVIKEN strainer and LILLVIKEN lid are included but packaged separately. Requires installation. W28¾×D17¼×H7¾".

Stainless steel 591.579.23

**HAVSEN Apron front sink, 2-bowls**

Ceramic sinks are kiln-fired, which makes each one unique, therefore the size may vary slightly from measurements given. Fits countertop with a minimum thickness of 1". LILLVIKEN strainer is included but packaged separately. Requires installation.

White 592.537.26

Strainer, lid and tools for sinks



The lid attaches via a magnet and can be used as a handle for lifting the basket. The lid creates a flat surface at the bottom of the sink and prevents food waste from getting into the basket, making the sink easy to keep clean.

**LILLVIKEN Lid**

Fits LILLVIKEN sink strainer. On top of the water trap the lid connects through a magnet which can be used as a handle to pick up the basket and throw away scraps.

Stainless steel 203.178.52

**LILLVIKEN Sink strainer**

Strainer and strainer basket.

Stainless steel 503.254.26

**KNIPEN Detergent dispenser**

Can be installed in a hole 1½-1¾" diameter. Dispenser can be filled from above.

Stainless steel-color 703.417.22

Kitchen faucets

Saving water at every step

Earth may be covered in a lot of water, but very little of it is drinkable and even less is accessible. No organism can survive without it, and no new water is created. It's constantly recycled, but our freshwater supply is overused; not evenly distributed; and impacted by pollution, contamination and climate change. That's why we equip all our kitchen faucets with a water saving aerator that reduces water use up to 40%—while maintaining the same pressure. We didn't invent aerators, but think they are an important example of how we can work together to save water for everyone's benefit.

10

All IKEA kitchen faucets come with a free 10-year limited warranty. Find out more on [page 136](#).



Functions



Kitchen faucets with low spout

Kitchen faucets with low spouts always have the handle on top, and are ideal for small single bowl sinks.

YTTRAN Kitchen faucet*



Kitchen faucets with high spout

The high spout makes it easier to wash dishes, including large pots.

INSJÖN Kitchen faucet*



Kitchen faucets with pull-out spout

Rinsing dishes is easier with the pull-out spout. A counterweight makes the hose easily retract back into the kitchen faucet.

ÄLMAREN Kitchen faucet with pull-out spout*



Kitchen faucet with sensor

The kitchen faucet's sensor function is simple, hygienic and practical—perfect when you just want to fill a glass with water or rinse off your hands when cooking.

TÄMNAREN Kitchen faucet with sensor*

Kitchen faucets with high spout



EDSVIK Dual control kitchen faucet H12¾". This faucet is for use on high pressure water systems. Tested to work with a max. pressure of 10 bar (1000 kPa). Recommended working pressure range is 1.0–5.0 bar (100 kPa–500 kPa). Swivel spout is preset to 360°. Also available with pull-out spout. Requires installation.

Chrome-plated 304.955.23



NYVATTNET Kitchen faucet H5¾". Swivel spout is preset to 360° but can be changed to 120°. Requires installation.

Chrome-plated 304.896.40



ÄLMAREN Kitchen faucet H14¼". Swivel spout is preset to 360° but can be changed to 120°. Also available with pull-out spout. Requires installation.

Stainless steel-color 503.416.43



DELSJÖN Kitchen faucet H14¼". Swivel spout is preset to 360° but can be changed to 120°. Requires installation.

Pewter-effect 704.887.90
Brass-color 104.780.44



GAMESJÖN Dual-control kitchen faucet H14¼". Swivel spout 360°. Requires installation.

Brushed black metal 903.416.79



INSJÖN Kitchen faucet H15¾". Swivel spout is preset to 360° but can be changed to 120°. Also available with pull-out spout. Requires installation.

Chrome-plated 203.701.23



GLITTRAN Kitchen faucet H11". Swivel spout 360°. Requires installation.

Brass-color 804.686.83

Kitchen faucets with low spout



LAGAN Kitchen faucet H6¾". Swivel spout: 360°. Requires installation.

Chrome-plated 700.850.29



SUNDSVIK Kitchen faucet H6". Swivel spout: 360°. Requires installation.

Chrome-plated 702.705.07



GLYPEN Kitchen faucet H10¼". Swivel spout is preset to 360° but can be changed to 90° or 120°. Requires installation.

Stainless steel-color 704.423.92



KALLSJÖN Kitchen faucet H6". For outdoor use. Quick-connect hose fitting for easy attachment included. Requires installation.

Chrome-plated 004.863.51



YTTRAN Kitchen faucet H7½". Swivel spout is preset to 360° but can be changed to 120°. Also available with pull-out spout. Requires installation.

Chrome-plated 603.059.46



BOSJÖN Kitchen faucet H12½". Swivel spout 120°. Requires installation.

Stainless steel-color 904.574.05

KITCHEN FAUCETS

Kitchen faucets with pull-out spout



YTRAN Kitchen faucet with pull-out spout
H7½". Swivel spout 120°. Also available without pull-out spout. Requires installation.

Chrome-plated 603.059.51



ÄLMAREN Kitchen faucet with pull-out spout
H14¼". Swivel spout 120°. Also available without pull-out spout. Requires installation.

Stainless steel-color 803.416.51



INSJÖN Kitchen faucet with pull-out spout
H16¾". Swivel spout 120°. Also available without pull-out spout. Requires installation.

Chrome-plated 703.418.78

Kitchen faucets with handspray



VITHAVET Kitchen faucet with separate handspray
H15¾". Handspray pulls out 27½". Requires installation.

Chrome-plated/black 003.419.28



VIMMERN Kitchen faucet with handspray
H18½". Swivel spout 360°. Requires installation.

Stainless steel-color 103.052.89



TOLLSJÖN Kitchen faucet with handspray
H18". Swivel spout is preset to 360° but can be changed to 120°. Requires installation.

Black polished metal 403.416.91
Chrome-plated 503.416.95

Kitchen faucets with sensor



TÄMNAREN Kitchen faucet with sensor
H12¼". The sensor is placed on the side of the faucet. The faucet has both sensor and manual lever. The water turns off automatically after 10 seconds if no motion is detected. Requires installation.

Stainless steel-color 303.595.06



INSJÖN Kitchen faucet with sensor
H15¾". Swivel spout is preset to 360° but can be changed to 120°. Also available without sensor function or with pull-out spout. Requires installation.

Chrome-plated 203.419.08



SEKTION cabinets

Modular cabinets that fits your space

What does your dream kitchen look like? How much time will you spend in it and how will you use it? When it comes to kitchens, we're all different. We have different dreams, different needs and different preconditions. To meet this diversity, what could be better than a highly flexible kitchen system with cabinets that can suit everyone, and be planned in everywhere? Whatever the size of your home or family, with cabinets in different sizes, drawers with endless possibilities and interior organizers made to match, you can turn the kitchen of your dreams into the kitchen in your home.

25

IKEA SEKTION kitchen has a free 25-year limited warranty.
Find out more on [page 136](#).



On this page you can see all available SEKTION cabinets and their sizes.
Choose and mix them to fit the architecture of your room as well as your own needs.



SEKTION Base cabinets

	SEKTION Base cabinet frame W12xD24xH30". White 102.653.92
	SEKTION Base cabinet frame W15xD24xH30". White 002.653.97
	SEKTION Base cabinet frame W18xD24xH30". White 202.653.96
	SEKTION Base cabinet frame W21xD24xH30". White 302.654.14
	SEKTION Base cabinet frame W24xD14¼xH30". White 402.653.95
	SEKTION Base cabinet frame W24xD24xH30". White 902.653.88
	SEKTION Base cabinet frame W30xD14¼xH30". White 502.653.90
	SEKTION Base cabinet frame W30xD24xH30". White 302.653.86
	SEKTION Base cabinet frame W36xD24xH30". White 802.653.98





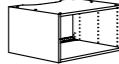
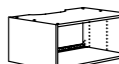





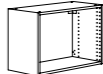





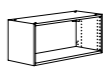

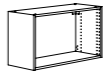
SEKTION Base cabinet for built-in oven

	SEKTION Base cabinet for oven W30xD24xH30". White 502.986.49
---	--



SEKTION Top cabinets

	SEKTION Fridge/freezer top cabinet frame W30xD24xH15". White 602.655.11
	SEKTION Fridge/freezer top cabinet frame W30xD24xH20". White 402.655.12
	SEKTION Fridge/freezer top cabinet frame W36xD24xH15". White 002.655.09
	SEKTION Fridge/freezer top cabinet frame W36xD24xH20". White 202.655.13

SEKTION Wall cabinets

	SEKTION Wall cabinet frame W12xD14¼xH30". White 102.654.72		SEKTION Wall cabinet frame W30xD14¼xH20". White 102.654.53
	SEKTION Wall cabinet frame W12xD14¼xH40". White 902.654.73		SEKTION Wall cabinet frame W30xD14¼xH30". White 702.654.69
	SEKTION Wall cabinet frame W15xD14¼xH30". White 902.654.54		SEKTION Wall cabinet frame W30xD14¼xH40". White 902.654.68
	SEKTION Wall cabinet frame W15xD14¼xH40". White 002.654.63		SEKTION Wall cabinet frame W36xD14¼xH15". White 402.654.56
	SEKTION Wall cabinet frame W18xD14¼xH30". White 802.654.64		SEKTION Wall cabinet frame W36xD14¼xH20". White 302.654.71
	SEKTION Wall cabinet frame W18xD14¼xH40". White 002.654.58		SEKTION Wall cabinet frame W36xD14¼xH30". White 902.654.49
	SEKTION Wall cabinet frame W21xD14¼xH30". White 502.654.51		SEKTION Wall cabinet frame W36xD14¼xH40". White 602.654.60
	SEKTION Wall cabinet frame W21xD14¼xH40". White 302.654.52		
	SEKTION Wall cabinet frame W24xD14¼xH15". White 302.654.66		
	SEKTION Wall cabinet frame W24xD14¼xH20". White 202.654.57		
	SEKTION Wall cabinet frame W24xD14¼xH30". White 702.654.50		
	SEKTION Wall cabinet frame W24xD14¼xH40". White 502.654.70		
	SEKTION Wall cabinet frame W30xD14¼xH15". White 202.654.62		

SEKTION Wall cabinet for built-in extractor hood

	SEKTION Wall cabinet for extractor hood with shelf W30xD14¼xH20". White 304.873.49
	SEKTION Wall cabinet for extractor hood with shelf W30xD14¼xH30". White 904.873.51



SEKTION High cabinets

	SEKTION High cabinet frame W15×D24×H80". White 802.654.40
	SEKTION High cabinet frame W15×D24×H90". White 102.654.48
	SEKTION High cabinet frame W18×D24×H80". White 002.654.44
	SEKTION High cabinet frame W18×D24×H90". White 002.654.39
	SEKTION High cabinet frame W24×D24×H80". White 202.654.38
	SEKTION High cabinet frame W24×D24×H90". White 702.654.45
	SEKTION High cabinet frame W30×D24×H80". White 204.874.15
	SEKTION High cabinet frame W30×D24×H90". White 404.874.19
	SEKTION High cabinet for fridge/freezer W24×D24×H80". White 804.997.31
	SEKTION High cabinet for fridge/freezer W24×D24×H90". White 004.997.30

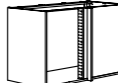
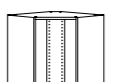
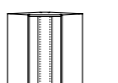
SEKTION Corner cabinets

	SEKTION Corner base cabinet frame W38×D38×H30". White 702.655.01
	SEKTION Corner base cabinet frame W47×D26×H30". White 502.655.02
	SEKTION Corner wall cabinet frame W26×D26×H30". White 102.655.04
	SEKTION Corner wall cabinet frame W26×D26×H40". White 302.655.03

NYTTIG Fillers and separators



	NYTTIG Filler piece for wall oven/microwave Used as filler between the oven and the microwave. 604.844.53
	NYTTIG Support bracket for microwave trim kit 104.844.55
	NYTTIG Cooktop/drawer separator Used for cooktop and drawer combination. 30" 602.906.76 36" 802.906.75

SEKTION Top rail

	SEKTION Reinforced ventilated top rail Galvanized. Use for sink and cook top base cabinet solutions.
L24"	002.845.79
L30"	802.845.80
L36"	602.845.81

Open storage

Create a nice break in a row of cabinets with doors using open cabinets. Your kitchen becomes more personal and you can have often-used items like cookbooks within arm's reach.

	TORNVIKEN Open cabinet 9×14½×15" Gray 803.590.28 Off-white 003.590.32
	9×14½×30" Gray 203.590.26 Off-white 103.590.36
	9×14½×40" Gray 003.590.27 Off-white 303.590.35



	TORNVIKEN Box 7½×13×5½". A flexible box that you can place in TORNVIKEN open cabinet and also lift out and place somewhere — like on the countertop or the dining table. Gray 603.590.29 White 803.590.33
---	--

	VADHOLMA Drawer unit 15×14½×15". Smooth-running drawers with stop, self-closing the last inches. You can view and access what's inside, as the drawers fully extend. Brown/stained ash 403.743.42
---	---

	VADHOLMA Open storage Brown/stained ash 9×14½×15" 203.743.43 9×14½×30" 003.743.44 9×14½×40" 703.743.45
---	--

	VADHOLMA Wine shelf 15×14½×15". Brown/stained ash 503.743.46
---	--

Wall storage

	TORNVIKEN Wall shelf Off-white 19½" 803.935.17
	47½" 603.916.61

MAXIMERA Drawers and drawer accessories

MAXIMERA drawers fully extend, and thanks to a built-in damper they always close softly and quietly. You have a complete view and you can easily reach the smallest of utensils even at the back of the drawer. MAXIMERA drawers are available in different sizes to give you plenty of options depending on your storage needs. You can also add inner drawers to fully utilize the cabinet space.

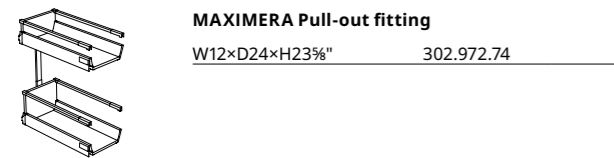

MAXIMERA Pull-out fitting		
W12×D24×H23½"	302.972.74	

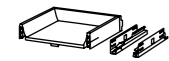

MAXIMERA Drawer low. White		
W15×D14¾×H3½"	302.656.59	
W18×D14¾×H3½"	502.656.58	
W24×D14¾×H3½"	402.656.54	
W30×D14¾×H3½"	102.656.60	
W36×D14¾×H3½"	102.656.55	
W15×D24×H3½"	502.656.63	
W18×D24×H3½"	702.656.57	
W24×D24×H3½"	702.656.62	
W30×D24×H3½"	902.656.56	
W36×D24×H3½"	902.656.61	

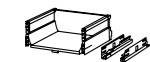

MAXIMERA Drawer medium. White		
W15×D14¾×H5½"	402.656.73	
W18×D14¾×H5½"	202.656.74	
W24×D14¾×H5½"	402.656.68	
W30×D14¾×H5½"	802.656.71	
W36×D14¾×H5½"	202.656.69	
W15×D24×H5½"	002.656.70	
W18×D24×H5½"	002.656.65	
W21×D24×H5½"	602.656.72	
W24×D24×H5½"	802.656.66	
W30×D24×H5½"	302.656.64	
W36×D24×H5½"	602.656.67	

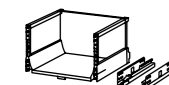

MAXIMERA Drawer high. White		
W24×D17¾×H8¾"	402.766.95	
W30×D17¾×H8¾"	202.766.96	
W36×D17¾×H8¾"	002.766.97	
W15×D24×H8¾"	302.656.78	
W18×D24×H8¾"	502.656.82	
W24×D24×H8¾"	102.656.79	
W30×D24×H8¾"	702.656.76	
W36×D24×H8¾"	102.656.84	



UTRUSTA Drawer front low. White		
W15×H3½"	402.656.25	
W18×H3½"	602.656.29	
W24×H3½"	802.656.28	
W30×H3½"	202.656.26	
W36×H3½"	002.656.27	



UTRUSTA Drawer front medium. White		
W15×H6½"	602.656.34	
W18×H6½"	102.656.36	
W21×H6½"	302.656.35	
W24×H6½"	202.656.31	
W30×H6½"	002.656.32	
W36×H6½"	802.656.33	



UTRUSTA Drawer front high. White		
W15×H8¾"	902.656.37	
W18×H8¾"	702.656.38	
W24×H8¾"	502.656.39	
W30×H8¾"	302.656.40	
W36×H8¾"	902.656.42	

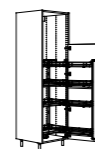

UTRUSTA Pull out larder. Galvanized		
Fitting only, cabinet and doors sold separately.		
W21¾×D22½×H49¾"	105.177.95	

MAXIMERA Add-ons and UPDATERA Dividers



MAXIMERA Add-on sides for drawer, medium Glass		
D14¾"	702.388.62	2pk
D24"	302.388.59	2pk



UPDATERA Divider for drawer White		
W15"	804.914.43	
W24"	604.914.44	
W30"	304.914.45	

New



MAXIMERA Add-on sides for drawer, high Glass		
D24"	502.388.58	2pk

UTRUSTA Shelves



UTRUSTA Shelves W12×D14¾"		
White	402.655.31	2pk



UTRUSTA Shelves W12×D24"		
White	902.655.24	2pk



UTRUSTA Shelves W15×D14¾"		
Glass	202.656.07	2pk
White	802.655.48	2pk



UTRUSTA Shelves W15×D24"		
White	602.655.25	2pk



UTRUSTA Shelves W18×D14¾"		
Glass	002.656.13	2pk
White	802.655.29	2pk



UTRUSTA Shelves W18×D24"		
White	202.655.32	2pk



UTRUSTA Shelves W21×D14¾"		
White	602.655.30	2pk



UTRUSTA Shelves W21×D24"		
White	202.655.27	2pk



UTRUSTA Shelves W24×D14¾"		
Glass	002.656.08	2pk
White	102.655.23	2pk



UTRUSTA Shelves W24×D24"		
White	002.655.33	2pk



UTRUSTA Shelves W30×D14¾"		
Glass	802.656.09	2pk
White	502.655.35	2pk



UTRUSTA Shelves W30×D24"		
White	002.655.28	2pk



UTRUSTA Shelves W36×D14¾"		
Glass	402.656.11	2pk
White	402.655.26	2pk



UTRUSTA Shelves W36×D24"		
White	802.655.34	2pk



UTRUSTA Shelf for corner base cabinet W47"		
White	102.656.22	



UTRUSTA Shelf for corner wall cabinet W26"		
Glass	802.656.14	
White	702.656.19	



UTRUSTA Reinforced ventilated shelf W30×D24"		
White	704.873.47	



UTRUSTA Pull-out work surface W22½×D21¾"		
	605.105.79	

UTRUSTA Corner interior



UTRUSTA Wall corner cabinet carousel		
Ø24"	802.656.47	

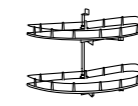

UTRUSTA Corner base cabinet pull-out fitting		
W47"	402.656.49	



UTRUSTA Corner base cabinet carousel		
Ø34½"	602.152.91	

UTRUSTA Wire basket



UTRUSTA Wire basket		
W15×D24"	802.656.52	
W18×D24"	202.656.50	
W24×D24"	002.656.51	



UTRUSTA Cleaning interior 14×22¾×53"		
Pull-out organizers make it easy for you to see and reach your cleaning supplies.		
	803.258.92	

SEKTION system fittings and hinges

Even the smaller details are important when you are planning a complete kitchen. It all depends on your needs and wishes—but maybe it's just this small part that will make a big difference.



SEKTION Suspension rail 84"

Galvanized 602.615.27



SEKTION Ventilation grill 16 7/8 x 3 3/4"

Stainless steel 702.561.77



MAKRILLA Ventilated plinth 20 1/8 x 4 1/2"

Stainless steel 403.238.09



UTRUSTA Push opener, electrical. You can open the waste sorting bin with the push of a finger – or use your hip, knee or foot if your hands are busy.

302.387.03



UTRUSTA Push openers Push to open; no handles needed.

802.302.24

2pk

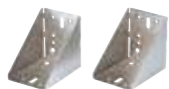

UTRUSTA Corner fittings By using the corner fitting, you can build a corner wall cabinet solution at a 90° angle.

Galvanized 103.436.44

2pk



UTRUSTA Hinges 45° The hinge is only for use with a corner wall cabinet and is only needed when you want to mount two doors on the cabinet.

202.619.92

2pk



UTRUSTA Hinges 95° Fits cabinets for built-in fridge/freezers.

202.046.47

2pk



UTRUSTA Hinges 110° With built-in damper.

805.248.82

2pk



UTRUSTA Hinges 153° With built-in damper. The extra wide opening angle of 153° makes it possible to have a drawer behind a door.

104.272.62

2pk



UTRUSTA Hinges with damper for horizontal door Door lift with catch for gentle closing included.

White 804.654.15

2pk



UTRUSTA Hinges with push opener for horizontal door Push to open, no handle needed. Door lift with catch included.

White 404.654.17

2pk



VARIERA Cover caps Covers drill holes in the glass door cabinet or open shelf. Suitable for all products with 3/16" holes.

White

002.263.15

100pk



UTRUSTA Connection fitting for doors UTRUSTA connection fitting for doors is used to connect two doors to one, so you get a uniform look, for example a high cabinet.

303.669.17



UTRUSTA Connecting rail for fronts You can easily align the drawer front with the other doors and drawer fronts in your kitchen and create a smooth, streamlined look with the help of UTRUSTA connection rail.

202.774.36



UTRUSTA Fitting for mounting drawer on door

002.807.55



UTRUSTA Assembly kit for pull-out function Allow you attach a door to your drawers to create a pull-out pantry storage, giving you a good overview of everything stored inside.

805.105.83



SEKTION Assembly kit for kitchen island The assembly kit makes it easy for you to mount cabinets back to back, or to attach a cover panel to the back of the base cabinets.

002.984.11



SEKTION Support bracket for kitchen island The support bracket keeps the island steady on uneven floors.

002.984.06



VAGLIG Connection rail for panel-ready dishwasher

904.247.02

SEKTION interior fittings and organizers

Hidden helpers

With SEKTION interior fittings and organizers, you can get the look you want on the outside without revealing what's inside. The cabinets can be hiding all sorts of kitchen surprises. Behind a door you can find pull-out organizers for your cleaning equipment, organizers keeping all your pots, pans and lids in perfect order, or a great bunch of fully extendable drawers making everything easy to reach. Not to mention drawers inside drawers allowing you to utilize the cabinet space to a maximum. It's really up to you what goes inside your kitchen cabinets.

On the following pages you'll find numerous handy helpers making your daily work in the kitchen so much easier.



Additional interior fittings and organizers



UTRUSTA Towel rail 6¼". It's easy to access towels because it pulls out.
White 502.472.16



VARIERA Box L9½×W6¾×H4¼".
Black 804.710.44
Gray 504.710.50
Green 104.710.47
White 301.550.19



VARIERA Box L13¼×W9½×H5¾".
White 701.772.55



VARIERA Pot lid organizer Stainless steel
L3¼-19¾×W5¾×H4" 701.548.00



VARIERA Plastic bag dispenser Ideal for storing things like plastic bags, toilet/kitchen rolls, gloves and socks.
White 800.102.22



VARIERA Drawer mat L59¼×W19¾".
Transparent 800.128.53



PASSARP Drawer mat L31×W20".
Gray 103.200.01



VARIERA Shelf insert White
W12½×D5½×H6¼" 801.366.22
W12½×D11×H6¼" 601.366.23



10. RISATORP Basket L9¾×W10¼×H7".
White 902.816.18
Pale blue 505.200.84
Gray 704.571.90



UPPDATERA series



UPPDATERA Flatware caddy L4¾×W4¾×H9½".
Anthracite 404.331.05



UPPDATERA Plate holder 6-9" Adjustable to fit your plates. Plate Ø6-9". W9-12×H6".
Anthracite 704.861.78



UPPDATERA Plate holder 7-12" Adjustable to fit your plates. Plate Ø7-12". W10-15×H6".
Anthracite 504.861.79



UPPDATERA Pegboard drawer organizer Includes 24 adjustable pegs. W18¾×D19½×H5¼".
Anthracite 604.600.08



UPPDATERA Pegboard drawer organizer Includes 32 adjustable pegs. W25×D19½×H5¼".
Anthracite 505.029.85



UPPDATERA Knife rack W4×D20".
Anthracite 804.913.63



UPPDATERA Spice rack W6×H20".
Anthracite 904.913.67



UPPDATERA Utensil tray W6×H12".
White 204.914.03



UPPDATERA Utensil tray W6×H19½".
White 604.913.64



UPPDATERA Flatware tray W15×D12".
White 404.914.02



UPPDATERA Flatware tray W12×D19½".
White 704.914.10



UPPDATERA Flatware tray W15×D19½".
White 604.942.06



UPPDATERA Adjustable add-on tray Plastic feet underneath keep the tray from sliding around when you open and close the drawer, even if your drawer is slightly bigger than the tray. W10×D19½".
White 405.134.18



UPPDATERA Flatware tray W6×D19½".
White/anthracite 194.327.11



UPPDATERA Tray with knife rack W6×D19½".
White/anthracite 594.326.91



UPPDATERA Utensil tray W6×H19½".
Light bamboo 004.913.57



UPPDATERA Flatware tray W12×D19½".
Light bamboo 204.914.84



UPPDATERA Flatware tray W15×D19½".
Light bamboo 204.913.56



UPPDATERA Tray with knife rack W6×D19½".
Light bamboo/anthracite 194.327.06



UPPDATERA Tray with spice rack W6×D19½".
Light bamboo/anthracite 294.327.82

Recycling

Our easy-to-clean bins are available in a variety of sizes so you can create the recycling solution that suits your needs. Pull-out functions can help make recycling and composting less of a chore.

Pull-out recycling tray

Make tossing things out and taking the bin to the curb more convenient.



Recycling center

Have two large bins for recycling paper, plastic, bottles and cans conveniently in your kitchen.



Recycling combinations

Choose the combination that best fits your needs. You can use waste bins behind cabinet doors or in high drawers.

24-30-36" cabinet with door/doors

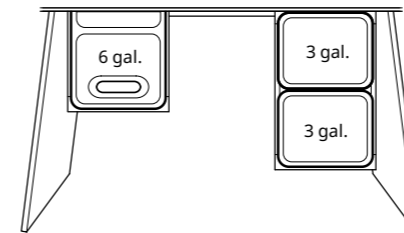

Behind cabinet doors, 36".

HÅLLBAR series

1 × Bin

6 gal. 204.202.03

2 × Bin

3 gal. 803.980.58

2 × Pull-out frame for recycling /ea
204.228.53

18" drawer

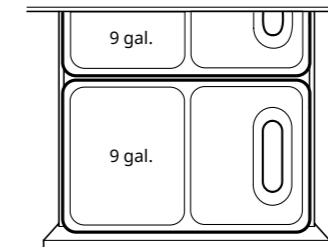

In a drawer, 18".

HÅLLBAR series

2 × Bin

9 gal. 504.202.06

30" drawer under sink

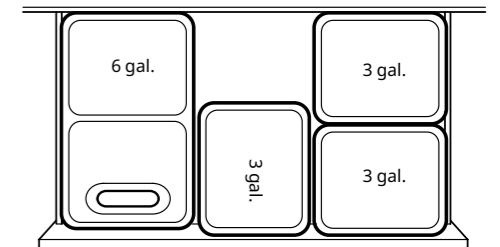

In a drawer under sink, 30".

HÅLLBAR series

1 × Bin

6 gal. 204.202.03

3 × Bin

3 gal. 803.980.58

HÅLLBAR recycling



HÅLLBAR Pull-out frame for recycling

L10³/₈×W17³/₄×H12³/₈" 204.228.53



HÅLLBAR Bin Light gray, 101 oz.

L7⁷/₈×W6³/₈×H6³/₄" 904.321.94



HÅLLBAR Bin Light gray, 3 gal.

L10³/₈×W8³/₈×H12³/₈" 803.980.58



HÅLLBAR Bin Light gray, 6 gal.

L15¹/₄×W10³/₈×H12³/₈" 204.202.03



HÅLLBAR Bin Light gray, 9 gal.

L15¹/₄×W9⁷/₈×H21³/₈" 504.202.06



HÅLLBAR Recycling solution with pull-out Light gray, 5 gal.

793.088.03



HÅLLBAR Recycling solution with pull-out Light gray, 6 gal.

093.088.25



VARIERA Bin White, 3 gal

L10³/₈×W18¹/₈×H6¹/₄" 801.822.37



UTRUSTA Push opener Electrical.

302.387.03

New

ENHET kitchen system

Plan less, live more

ENHET is easy to buy and equally easy to update if you need to, or simply feel like it. You can choose between ready-made combinations online and buy your favorite with a few clicks. All parts are easy to assemble, intuitively and without any special tools.

The playful design in different colors inspires you to adapt ENHET to reflect your personality. With a combination of open frames and closed cabinets you can display your favorite things and hide the rest. The ENHET kitchen units also come in different widths and depths, making them easy to adapt to a smaller space.

Helping you keep your kitchen utensils neatly organized and close at hand, the ENHET accessories include a hook rail that can be moved around without having to drill into the wall, a swivel shelf for smaller items and a hanging shelf insert that you simply hang in the grooves of an open frame to maximize storage space — no tools needed.

10

The ENHET kitchen has a 10-year limited warranty. Find out more on page 136.



ENHET complete kitchens

Getting a complete kitchen has probably never been easier. We have combined ENHET units into a number of practical solutions that you can find online and buy directly, so all you have to do is find the kitchen that fits your needs and matches your temperament. By combining open and closed

storage, different colors and adding the accessories you want, you can have a fully functional and personalized kitchen up and running in no time.



ENHET K200



ENHET K201



ENHET K202



ENHET K400



ENHET K401



ENHET K402



ENHET K203



ENHET K204



ENHET K205



ENHET K403



ENHET K404



ENHET K405



ENHET K206



ENHET K207



ENHET K406

ENHET complete kitchens

Pick, click, buy and assemble — you are just a few steps away from cooking and hanging out in your kitchen. It's time to get into details and find a solution that offers the size, storage possibilities, color(s) and accessories that you prefer. In the following you can find the information about the different

combinations that you need to make your final decision. After having selected your favorite layout, you can style it to suit you even more by customizing features such as fronts, countertop, knobs/handles and add the appliances needed in the kitchen configurator online.



ENHET K200
W97×D25½×H84½" (W246.4×D65×H214.6 cm)

All you need for kitchen work to flow smoothly in one compact solution. With open and closed storage, a functional work area and smart use of space for cooking, everyday life in the kitchen is easier.

This combination with	White frame	Anthracite frame
White fronts	194.408.29	—

Note! Appliances and lighting products are sold separately.



ENHET K201
W85×D25½×H84½" (W216×D65×H214.6 cm)

Everything is within arm's reach in this practical kitchen solution. There's room for dicing your veggies and cooking your food — and there's plenty of storage space too.

This combination with	White frame	Anthracite frame
Gray/white frame fronts	694.408.41	—

Note! Appliances and lighting products are sold separately.



ENHET K204
W115×D25½×H100" (W292.1×D65×H254 cm)

A lovely space to cook and workspace on both sides of the sink giving you plenty of room to prepare food. The ceiling is the limit with the wall frame that lets you showcase your favorite things.

This combination with	White frame	Anthracite frame
Oak effect fronts	—	894.408.59

Note! Appliances and lighting products are sold separately.



ENHET K205
W85×D25½×H84½" (W216×D65×H214.6 cm)

Everything is within arm's reach in this practical kitchen solution. There's room for dicing your veggies and cooking your food and there's plenty of storage space too.

This combination with	White frame	Anthracite frame
White fronts	094.428.81	—

Note! Appliances and lighting products are sold separately.



ENHET K202
W85×D25½×H84½" (W216×D65×H214.6 cm)

Everything is within arm's reach in this practical kitchen solution. There's room for dicing your veggies and cooking your food — and there's plenty of storage space too.

This combination with	White frame	Anthracite frame
Gray frame fronts	—	594.408.51

Note! Appliances and lighting products are sold separately.



ENHET K203
W85×D25½×H84½" (W216×D65×H214.6 cm)

Everything is within arm's reach in this practical kitchen solution. There's room for dicing your veggies and cooking your food — and there's plenty of storage space too.

This combination with	White frame	Anthracite frame
Oak effect fronts	294.408.57	—

Note! Appliances and lighting products are sold separately.



ENHET K206
W92×D25½×H84½" (W233.7×D65×H214.6 cm)

Your passion for cooking won't be compromised in this space-wise kitchen. It has all the open and closed storage you need as well as generous space planned for cooking in one clever solution.

This combination with	White frame	Anthracite frame
White fronts	—	194.429.94

Note! Appliances and lighting products are sold separately.



ENHET K207
W102¾×D25½×H84½" (W261×D65×H214.6 cm)

A space-wise kitchen that's big on storage — and more! There's plenty of room for rinsing veggies, preparing food and cooking, and the high cabinet serves as a spacious pantry for dry foods.

This combination with	White frame	Anthracite frame
White fronts	794.444.19	—

Note! Appliances and lighting products are sold separately.



ENHET K400
W75¼/75¾×D25½×H84½" (W191.1/192.4×D65×H214.6 cm)

A lovely kitchen that uses the corner area to create generous space for storage and preparing food. There's open storage for often-used items and a wall frame that lets you showcase your favorite things.

This combination with	White frame	Anthracite frame
Gray frame fronts	—	794.410.05

Note! Appliances and lighting products are sold separately.



ENHET K401
W75¾/89¾×D25½×H84½" (W192.4/227×D65×H214.6 cm)

Wherever you turn, there's room to prepare food, cook or wash up and the corner area provides extra depth for working and storing. The mix of open and closed storage keeps everything close at hand.

This combination with	White frame	Anthracite frame
Oak effect fronts	394.410.07	—

Note! Appliances and lighting products are sold separately.



ENHET K404
W92¾/96¾×D25½×H84½" (W235.9/245.7×D65×H214.6 cm)

Wherever you turn, you have zones for working and storing. There's a spacious area for cooking and the open corner solution creates extra depth for preparing food and keeping things within easy reach.

This combination with	White frame	Anthracite frame
White fronts	294.410.03	—

Note! Appliances and lighting products are sold separately.



ENHET K405
W89¾/99¾×D25½×H84½" (W227/253.4×D65×H214.6 cm)

This kitchen has lots of room to socialize and help out, with space on both sides of the sink that can be turned into work stations in no time. The corner area provides extra depth, creating roomy storage.

This combination with	White frame	Anthracite frame
Gray frame fronts	194.410.13	—

Note! Appliances and lighting products are sold separately.



ENHET K402
W81¾/89¾×D25½×H84½" (W207.6/227×D65×H214.6 cm)

A big-hearted kitchen with ample room planned for slicing, dicing and cooking — the secret ingredient is the corner area that offers extra depth for storing and working.

This combination with	White frame	Anthracite frame
White frame fronts	994.410.09	—

Note! Appliances and lighting products are sold separately.



ENHET K403
W77¾/75¾×D25½×H96" (W197.2/192.4×D65×H243.8 cm)

When you love to show your things and keep them within arm's reach. This is a kitchen of convenience balanced with personal atmosphere, generous working space and plenty of closed storage.

This combination with	White frame	Anthracite frame
White fronts	—	194.409.47

Note! Appliances and lighting products are sold separately.



ENHET K406
W63¼/123¾×D25½×H96" (W160.6/314.6×D65×H243.8 cm)

Life in the kitchen is more fun when there's room for more than one — and easier too with convenient wall storage that doesn't compromise on workspace as well as room for the cooking functions you need.

This combination with	White frame	Anthracite frame
White frame fronts	594.410.11	—

Note! Appliances and lighting products are sold separately.

ENHET storage combinations

ENHET is all about simplicity and the possibility to change and adapt your home when your life changes. No matter what happens, everyday life becomes much easier when all things can be found in their designated place, especially if floorspace

is limited. That is why we have developed these combinations that can create extra work and/or storage space. Pick the one that best suits your needs and helps you use your space efficiently.



ENHET A200 wall storage combination
W50×D25½" (W127×D65 cm)

This solution offers generous closed storage along the wall allowing you to hide the clutter and an open unit beneath to store often-used items. There's a handy workspace too — you're welcome.

This combination with	White frame	Anthracite frame
White fronts	494.442.89	394.442.75
White frame fronts	694.442.88	294.442.85
Gray frame fronts	—	894.442.87
Oak effect fronts	594.442.84	—

Note! Knobs/handles and lighting products are sold separately.



ENHET A201 wall storage combination
W50×D25½" (W127×D65 cm)

A compact solution with a mix of easy-reach shelves and clutter-concealing drawers — whatever your space or storage needs, this easy-fit combo is ready to please.

This combination with	White frame	Anthracite frame
White fronts	—	294.442.90

Note! Knobs/handles and lighting products are sold separately.



ENHET A204 wall storage combination
W36×D12¾×H72" (W91.2×D32.4×H182.8 cm)

Set the style by showcasing your favorite objects in the open shelves and framing them in with cabinets on the sides. You get a generous storage solution with a calm and harmonious expression.

This combination with	White frame	Anthracite frame
White fronts	894.442.49	094.442.53
White frame fronts	494.442.51	894.442.54
Gray frame fronts	—	294.442.52
Oak effect fronts	694.442.50	—

Note! Knobs/handles and lighting products are sold separately.



ENHET A205 wall storage combination
W24×D12¾×H90" (W60.9×D32.4×H228.6 cm)

This combo makes good use of the wall space while taking up minimal floor space. You can keep special items dust-free behind doors and create a statement with your favorite objects on the open shelves.

This combination with	White frame	Anthracite frame
White fronts	394.443.36	994.443.24
White frame fronts	194.443.37	694.443.25
Gray frame fronts	—	594.443.35
Oak effect fronts	894.443.34	—

Note! Knobs/handles and lighting products are sold separately.



ENHET A202 wall storage combination
W48×D12¾×H60" (W121.8×D32.4×H152.4 cm)

A mix of open and closed storage that allows you to show or not to show. Put your favorite objects on display and hide the messy stuff. A clever combo that can be placed almost anywhere in your home.

This combination with	White frame	Anthracite frame
White fronts	594.442.41	394.442.37
White frame fronts	394.442.42	194.442.38
Gray frame fronts	—	794.442.40
Oak effect fronts	994.442.39	—

Note! Knobs/handles and lighting products are sold separately.



ENHET A203 wall storage combination
W48×D12¾×H72" (W121.8×D32.4×H182.8 cm)

This generous solution is a great choice if you have wall space but not so much floor space. It offers a place to showcase objects and cabinets to neatly tuck things away in one smart, cohesive combo.

This combination with	White frame	Anthracite frame
White fronts	194.442.43	294.442.47
White frame fronts	694.442.45	094.442.48
Gray frame fronts	—	494.442.46
Oak effect fronts	994.442.44	—

Note! Knobs/handles and lighting products are sold separately.



ENHET A206 wall storage combination
W24×D6¾×H90" (W60.9×D17.2×H228.6 cm)

This shallow combination makes good use of the wall space while taking up very little floor space. Keep cluttering items behind doors and use the shelves for easy access to things often used.

This combination with	White frame	Anthracite frame
White fronts	794.442.59	594.442.55
White frame fronts	594.442.60	394.442.56
Gray frame fronts	—	994.442.58
Oak effect fronts	194.442.57	—

Note! Knobs/handles and lighting products are sold separately.



ENHET A208 wall storage combination
W60×D12¾×H30" (W152.4×D32.4×H76.2 cm)

All the storage you need in one compact solution. The shelves offer an overview and easy access to your everyday items, while the cabinets keep the other stuff out of sight and create a calm expression.

This combination with	White frame	Anthracite frame
White fronts	294.442.71	094.442.67
White frame fronts	094.442.72	894.442.68
Gray frame fronts	—	494.442.70
Oak effect fronts	694.442.69	—

Note! Knobs/handles and lighting products are sold separately.



ENHET A211
W52×D25½×H84½" (W132.1×D65×H214.6 cm)

A great choice if you need a multifunctional combination with ample closed storage and open units to keep your most wanted items at hand. There's space to sit down and take a break too — you're welcome.

This combination with	White frame	Anthracite frame
White fronts	—	194.443.42

Note! Knobs/handles and lighting products are sold separately.



ENHET A212
W72×D25½×H84½" (W182.9×D65×H214.6 cm)

This combo makes good use of the walls to create sought-after storage space. There is a generous mix of open and closed storage so you can decide what to keep handy and what to keep out of sight.

This combination with	White frame	Anthracite frame
White fronts	—	994.443.43
White frame fronts	—	794.900.72

Note! Knobs/handles and lighting products are sold separately.



ENHET
 Wall storage combination,
 Anthracite/white frame,
 W50×D25½" (W127×D65 cm)
 294.442.85

ENHET doors and drawer fronts

Show your true colors

Whether you are set on a classic single color look or prefer a funkier mix of different hues, ENHET offers a range of doors that will accommodate your wishes. There is a variation of colors that brings a clean, bright and fresh look to your kitchen, which you can match with every color of the rainbow. Naturally, you can also mix colors and patterns

for a truly personalized kitchen, and combine closed doors with open shelves for a more playful expression. No matter the style you choose, the surface of the doors resists moisture, scratches and bumps, which means that your kitchen is well prepared to handle years of daily wear and tear.

10

The ENHET kitchen has a 10-year limited warranty. Find out more on page 136



ENHET door and drawer front styles

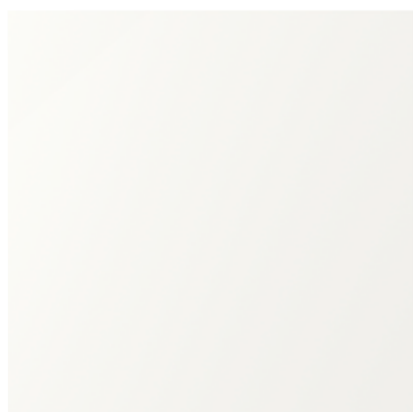

White

With white doors and drawer fronts you create a clean, bright and fresh expression that you can match with accents in all colors of the rainbow. Easy to enjoy and always in style.

Door

12×15" (30.2×37.8 cm), 2pk	305.155.59
15×15" (37.8×37.8 cm), 2pk	505.155.58
12×30" (30.2×75.9 cm)	305.153.52
18×30" (45.4×75.9 cm)	105.153.53
12×72" (30.2×182.6 cm)	205.153.57
18×50" (45.4×126.7 cm)	105.264.84

Drawer front

12×6" (30.2×14.9 cm)	805.153.59
18×6" (45.4×14.9 cm)	405.153.61
24×6" (60.6×14.9 cm)	005.153.63
12×12" (30.2×30.2 cm), 2pk	605.153.60
18×12" (45.4×30.2 cm), 2pk	205.153.62
24×12" (60.6×30.2 cm), 2pk	805.153.64



Oak effect

Good sense and feel in beautiful partnership. The foil surface resists moisture, scratches and bumps, while the wood pattern creates a lively and warm expression.

Door

12×15" (30.2×37.8 cm), 2pk	105.155.55
15×15" (37.8×37.8 cm), 2pk	405.155.54
12×30" (30.2×75.9 cm)	105.153.86
18×30" (45.4×75.9 cm)	905.153.87
12×72" (30.2×182.6 cm)	505.153.89
18×50" (45.4×126.7 cm)	305.264.83

Drawer front

12×6" (30.2×14.9 cm)	105.153.91
18×6" (45.4×14.9 cm)	705.153.93
24×6" (60.6×14.9 cm)	205.153.95
12×12" (30.2×30.2 cm), 2pk	905.153.92
18×12" (45.4×30.2 cm), 2pk	505.153.94
24×12" (60.6×30.2 cm), 2pk	005.153.96



White frame

A white surface with a wide frame is like an empty canvas where your choice of accessories and accent colors sets the style. Modern or classic — you decide.

Door

12×15" (30.2×37.8 cm), 2pk	705.155.57
15×15" (37.8×37.8 cm), 2pk	905.155.56
12×30" (30.2×75.9 cm)	805.154.01
18×30" (45.4×75.9 cm)	605.154.02
12×72" (30.2×182.6 cm)	205.154.04
18×50" (45.4×126.7 cm)	805.264.85

Drawer front

12×6" (30.2×14.9 cm)	805.153.59
18×6" (45.4×14.9 cm)	405.153.61
24×6" (60.6×14.9 cm)	005.153.63
12×12" (30.2×30.2 cm), 2pk	705.154.06
18×12" (45.4×30.2 cm), 2pk	505.154.07
24×12" (60.6×30.2 cm), 2pk	305.154.08



Gray frame

With gray as a base, you create a warm and cozy feeling. Perfect if you want a discreet color that goes with everything. Modern or classic — you decide the style.

Door

12×15" (30.2×37.8 cm), 2pk	605.155.53
15×15" (37.8×37.8 cm), 2pk	805.155.52
12×30" (30.2×75.9 cm)	305.153.71
18×30" (45.4×75.9 cm)	105.153.72
12×72" (30.2×182.6 cm)	705.153.74
18×50" (45.4×126.7 cm)	505.264.82

Drawer front

12×6" (30.2×14.9 cm)	205.153.76
18×6" (45.4×14.9 cm)	805.153.78
24×6" (60.6×14.9 cm)	405.153.80
12×12" (30.2×30.2 cm), 2pk	005.153.77
18×12" (45.4×30.2 cm), 2pk	605.153.79
24×12" (60.6×30.2 cm), 2pk	205.153.81



ENHET cabinets and frames

Keep an open mind!

In an ever-changing world, the only thing you can be certain of is that you and your home will have to change with it. That is why ENHET offers so many combinations that can be adapted over time to accommodate any life situation — or simply a change in taste.

With this range of cabinets and frames you can create a kitchen that fits both your needs and personality. The open wall frames make good use of the space

above the sink and countertop, perfect for hanging utensils or placing your tableware and other things that you often use. The choice of wide and narrow cabinets, as well as deep and shallow frames, gives you a great opportunity to use your space efficiently. Easily adaptable, and with a 10-year limited warranty, this practical kitchen will be your companion for years to come.

10

The ENHET kitchen has a 10-year limited warranty. Find out more on page 136



ENHET cabinets

This range of ENHET cabinets gives you a great opportunity to use your space efficiently. Choose the ones that fit both your needs and personality.



ENHET Wall cabinet This wall cabinet provides extra storage without taking up too much space. It makes efficient use of wall space and offers convenient storage wherever you need it in the home.

24×12×15" (60.9×30.4×38.1 cm)	
White	005.144.86
30×12×15" (76.2×30.4×38.1 cm)	
White	805.144.87



ENHET Wall cabinet with two shelves A wall cabinet with two shelves that makes good use of your wall space and puts the things you use often within easy reach.

18×6×30" (45.7×15.2×76.2 cm)	
White	805.155.71
Gray	005.155.70
24×6×30" (60.9×15.2×76.2 cm)	
White	405.155.73
Gray	605.155.72



ENHET Wall cabinet with two shelves This wall cabinet with two shelves puts bottles, jars and things often used within easy reach.

12×12×30" (30.4×30.4×76.2 cm)	
White	905.144.39
18×12×30" (45.7×30.4×76.2 cm)	
White	505.144.41
24×12×30" (60.9×30.4×76.2 cm)	
White	305.144.42



ENHET High cabinet with four shelves A spacious cabinet with four shelves that works perfectly as a kitchen pantry cabinet, allowing you to have your most essential ingredients at home and close at hand.

18×24×80" (45.7×60.9×203.2 cm)	
White	905.261.02



ENHET High cabinet with four shelves This high cabinet with four shelves provides ample storage without taking up too much floor space. Perfect for making the best use of wall space in smaller spaces.

12×12×72" (30.4×30.4×182.8 cm)	
White	205.155.69
Gray	405.155.68



ENHET Base cabinet with shelf A cabinet with a shelf that provides space for storing cooking equipment like bowls or small appliances.

12×24×30" (30.4×60.9×76.2 cm)	
White	605.144.31
18×24×30" (45.7×60.9×76.2 cm)	
White	405.144.32
24×24×30" (60.9×60.9×76.2 cm)	
White	205.144.33



ENHET Base cabinet with three drawers This cabinet has three drawers for convenient storage of the smallest utensils to the largest pots.

12×24×30" (30.4×60.9×76.2 cm)	
White	005.144.34
18×24×30" (45.7×60.9×76.2 cm)	
White	705.144.35
24×24×30" (60.9×60.9×76.2 cm)	
White	305.144.37



ENHET Corner base cabinet Pair this base cabinet with a corner panel to create a spacious corner solution. The cabinet makes good use of corner spaces with plenty of room for larger pots, pans and small appliances.

36×24×30" (91.4×60.9×76.2 cm)	
White	005.193.18



ENHET Base cabinet for sink This cabinet is designed for a sink and faucet and has space in the back for piping.

24×24×30" (60.9×60.9×76.2 cm)	
White	105.144.38

Legs and plinth for cabinets



ENHET Corner panel This panel makes it possible to build a corner solution with a corner base cabinet and opens up to more possibilities to utilize your space. Fits ENHET corner base cabinet.

24×30" (61×76.2 cm)	
White	605.153.55
Gray	705.153.69
Oak effect	605.153.84



ENHET End panel The end panel can be used to cover the side of a dishwasher or fridge, or to create a gap in a row of base cabinets. Use this to create a uniform and finished look.

25×30" (62.7×76.2 cm)	
White	105.153.67



ENHET Legs for cabinet 4½" (11.4 cm), 2pk Fits ENHET base and high cabinets.

White	605.144.26
Anthracite	805.144.25



ENHET Plinth 72×4½" (182.8×11.4 cm).

White	505.153.65
-------	------------

ENHET open frames

Open storage creates a dynamic and airy kitchen atmosphere. ENHET open frames allow you to express your personality through the items you choose to arrange and display on the shelves. For even more personalization options, the frames come in two colors that you can mix and match any way that suits you.

Open storage also provides a good overview of all your kitchen items, and you can keep the things you use the most on the shelves for easy access. With a mix of closed and open storage, it is possible to create a kitchen that doesn't only make preparing your everyday meals a breeze, but is a real eye-catcher that inspires you to cook and your friends and family to keep you company.



ENHET Wall frame with shelves 6" (15.2 cm) deep.

18×6×30" (45.7×15.2×76.2 cm)	
White	105.144.57
Anthracite	305.144.56
24×6×30" (60.9×15.2×76.2 cm)	
White	205.158.85
Anthracite	705.158.83



ENHET Wall frame with shelves 12" (30.4 cm) deep.

18×12×30" (45.7×30.4×76.2 cm)	
White	005.222.74
Anthracite	205.222.73
24×12×30" (60.9×30.4×76.2 cm)	
White	705.144.59
Anthracite	905.144.58



ENHET Base frame with shelves 24" (60.9 cm) deep.

18×24×30" (45.7×60.9×76.2 cm)	
White	805.144.54
Anthracite	505.144.55
24×24×30" (60.9×60.9×76.2 cm)	
White	205.144.52
Anthracite	005.144.53



ENHET High frame with shelves

12×12×72" (30.4×30.4×182.8 cm)	
White	805.158.92
Anthracite	005.158.91



ENHET High frame with shelves

24×12×80" (60.9×30.4×203.2 cm)	
White	905.144.82
Anthracite	305.144.61

Legs for frame



ENHET Legs for frame 4½" (11.4 cm), 2pk Fits ENHET base and high frames. Adjustable within 1".

White	605.144.45
Anthracite	105.144.43

ENHET accessories for open frame

You can easily add ENHET accessories to extend the use of your combination. And best of all — you don't have to drill.



ENHET Hanging shelf insert 10x11x6" (25.4x28x15.2 cm). This insert adds a new dimension to your ENHET frame. It divides the storage space and makes room for more things in no time — simply hang it in the grooves of the frame and get organized. You don't need any tools and don't have to drill holes in the wall.

Anthracite	405.145.59
------------	------------



ENHET Swivel shelf 16x8" (40.6x20.3 cm). Tired of looking for those things that tend to disappear in the kitchen? You can easily solve this by attaching this handy swivel shelf to any of the wall frames in the ENHET series. You can find and reach the things you need by turning the shelf. Perfect to have as a spice rack to keep all the flavors close at hand when you are cooking.

Anthracite	205.145.60
------------	------------



ENHET Hooks 2pk You can hang these hooks in the grooves under the ENHET frames — or on ENHET rail for hooks that is sold separately. With these hooks, you turn unused space into practical storage space. Perfect for everything from utensils to towels in the kitchen. Hang SKATTÅN containers, sold separately, on the hooks to make room for even more.

White	004.657.54
Anthracite	604.657.51



ENHET Rail for hooks With this rail you can utilize every inch under your ENHET frame for storage. In no time, you can create plenty of space for cutlery or utensils by adding ENHET hooks and SKATTÅN container, sold separately.

18" (45.7 cm)

White	705.145.53
Anthracite	905.145.52

24" (60.9 cm)

White	005.145.56
Anthracite	205.145.55



SKATTÅN Container Ø4¾, H13¾" (12x34 cm). Instead of storing things in drawers, you can have everything from cutlery to accessories close at hand. Hang this container on a hook under ENHET frames to quickly turn the space into practical storage.

Black	304.657.57
-------	------------



TAVELÅN Trays 2pk 1 tray W5¾xD5¾xH3¾" and 1 tray W11¾xD5¾xH3¾". Dimensioned for ENHET wall frames or other cabinets with a depth of 5¾ or 11¾". With these decorative trays you make room for a lot, even in small spaces. If you stack them, they'll take up even less space. Fits perfectly in ENHET wall frames, but you can of course use them wherever you want.

Bamboo	504.657.56
--------	------------



ENHET Swivel shelf
Anthracite, 16x8"
(40.6x20.3 cm).
205.145.60

Lighting for ENHET

SKYDRAG series



SKYDRAG lighting kit is designed for the ENHET series, perfect both as countertop lighting and to create ambience in the kitchen. With the TRÅDFRI driver and the wireless dimmer, you can easily turn on, off and dim your lighting.



SKYDRAG LED countertop/wardrobe lighting strip with sensor, dimmable.

12"	
White	004.791.62
18"	
White	004.395.95
Anthracite	904.396.09
24"	
White	404.396.02
Anthracite	104.791.66

TRÅDFRI series



With the TRÅDFRI gateway you can control all your TRÅDFRI driver-connected lighting via the IKEA Home smart app or your voice assistant. Create moods and set scenes together with other IKEA smart lighting.



TRÅDFRI Wireless dimmer

White	104.085.98
-------	------------



STYRBAR Remote control

With this remote control you can turn on and off, switch between different tones and dim for the right mood.

White	804.883.70
Stainless steel	504.636.15



TRÅDFRI Gateway

With TRÅDFRI gateway and app you can control each light source individually, create different types of lighting settings and control them by the IKEA Home smart app or personal assistant via, for example, Apple HomeKit, Amazon Alexa or Google Home.

White	003.378.13
-------	------------



TRÅDFRI LED driver

Must be completed with ANSLUTA power supply cord, sold separately. Can be used with TRÅDFRI remote control and TRÅDFRI gateway.

Holds 3 lights or max 10W	103.561.89
Holds 6 lights or max 30W	603.426.61

Cords and IKEA LED driver



ANSLUTA Power supply cord This cord is the power source for TRÅDFRI LED drivers. With this cord, you can connect up to 10 LED drivers of connected lamps to the power grid — and turn on, turn off and dim all of them at the same time with TRÅDFRI wireless dimmer.

L11'6"	301.214.11
--------	------------



ANSLUTA Intermediate connection cord. Can be used as a direct connection between TRÅDFRI LED drivers, e.g. between two sections of wall cabinets, with one single connection to the mains with ANSLUTA power supply cord.

L28"	401.199.26
L79"	601.199.25



ANSLUTA LED driver with power cord 19W Use this driver if you want turn all connected light sources on and off with a single switch. *Does not work with TRÅDFRI dimmer, remote control or gateway.

L11'6"	904.058.45
--------	------------

Complete your combination with lighting

How to build

SKYDRAG LED cabinet lighting is easy to install by yourself.

- When you start building your system, you must first consider the widths of your cabinets. For example, for a cabinet with a width of 23 3/4", you'll need the SKYDRAG lighting strip 23 3/4" too.
- Choose the number of SKYDRAG lighting strips that you need.
- Add the TRÅDFRI driver. You can connect up to 3 or 9 units to the driver, as long as the total wattage does not exceed 10W or 30W. TRÅDFRI drivers need to be connected to the plug with an ANSLUTA power cable.

- Add TRÅDFRI or STYRBAR wireless dimmer to dim your lighting. Pair the dimmer to the TRÅDFRI driver and the entire combination will dim at the same time.
- Add the TRÅDFRI gateway to control SKYDRAG connected lighting from the IKEA Home smart app in different ways together with other TRÅDFRI lighting in your home.

Basic parts



SKYDRAG
LED countertop/wardrobe lighting strip with sensor



TRÅDFRI
LED drivers



ANSLUTA
Power supply cord



ANSLUTA
Intermediate connection cord



TRÅDFRI
Wireless dimmer



STYRBAR
Wireless dimmer

Installation accessories



TRÅDFRI
Gateway

Combination



Product name

SKYDRAG LED countertop/wardrobe lighting strip with sensor 12" (30.5 cm), 3W, white	004.791.62	2 pcs
TRÅDFRI Driver for wireless control, 10W	103.561.89	1 pc
ANSLUTA Power supply cord, 11'6" (35 cm)	301.214.11	1 pc
TRÅDFRI Wireless dimmer	104.085.98	1 pc

How to mount SKYDRAG for ENHET kitchen series

There are a few different ways to mount SKYDRAG on ENHET open and closed solutions, see examples below.

The detailed information on how to do this is available in the Assembly Instructions for your products.

ENHET open frames



On top of frame



Under shelf

ENHET closed solutions



Under cabinet

Kitchen accessories, carts and islands

A kitchen easy to live in

Your kitchen isn't fully functional until everything in it has found a place of its own. With smart organizers and accessories, you'll find what you need, when you need it.

Utilize the full area in the kitchen, even the walls. With smart wall storage often-used items can be close at hand, at the same time you free up workspace.

Your best kitchen friends

Our carts and islands boost your storage space and kitchen functionality while adding a social focal point in your kitchen at the same time.

The sink area is a busy place. We have accessories with multiple purposes that can help you utilize the area in and around the sink, supporting the workflow both when preparing food and washing up.



Rails and accessories

Our selection of kitchen helpers gives you more work and storage space without the expense of a remodel.



KUNGSFORS series



KUNGSFORS Net bags

Natural 203.728.34 **set of 2**



KUNGSFORS Net bag

Blue 505.189.34
Green 105.147.87



KUNGSFORS Container Ø4¾, H10¾"

Stainless steel 003.349.18



KUNGSFORS Container W9½×D4¾×H10¾"

Stainless steel 603.349.20



KUNGSFORS Dish drainer W23½×D11¾×H4"

Stainless steel 403.712.25



KUNGSFORS Rail Stainless steel.

W15¾" 004.424.99
W22" 403.349.16



KUNGSFORS S-hooks Stainless steel.

H2¼" 203.349.22 **5pk**



KUNGSFORS Tablet stand Stainless steel.

W10¼×D5½×H4¾" 203.349.17



KUNGSFORS Magnet knife rack Stainless steel.

W22" 403.349.21



KUNGSFORS Magnetic clips Stainless steel.

H3¼" 003.349.23 **3pk**



KUNGSFORS Wall grid W22×H10½"

Stainless steel 803.349.19



KUNGSFORS Shelf W23½×D11¾"

Ash 903.712.23
Stainless steel 503.349.25
Bamboo 004.017.81



KUNGSFORS Suspension rail, L31½"

Stainless steel 803.348.58

KUNGSFORS combinations



KUNGSFORS Suspension rail with shelf/ wall grid W25¼×D12¾×H31½"

A stainless steel combination which includes two shelves that allow you to see what is on the shelf from underneath. On the wall grid you can create more storage space by hanging utensils using the S-hooks or containers in this series.

Stainless steel 192.543.32



KUNGSFORS Suspension rail with shelf/ magnet knife rack W25¼×D12¾×H31½"

This combination comprises three shelves in ash that help you store what you need, while providing a mixture of materials that feel warm and professional in the kitchen. The magnetic knife rack makes it easy to see and reach all your different knives when cooking.

Ash/stainless steel 392.543.26

SUNNERSTA series



SUNNERSTA Rail with four hooks/two containers L23¾×D5½×H5½"

White 404.545.60



SUNNERSTA Drill-free adjustable rack W18×H17¾-25½"

White 204.409.51



SUNNERSTA Container 4¾×6¾"

White 503.037.35
Green 904.405.23



SUNNERSTA Hooks

403.037.26 **5pk**



SUNNERSTA Shelf

L9¾×D5½×H2" 904.439.27



SUNNERSTA Shelf/dish drainer

L14¾×D5¾" 304.439.30



SUNNERSTA Paper towel holder

L11" 805.000.08

Rails and accessories

HULTARP series



HULTARP Container W5½×D6¼×H4¾".		
Black	304.444.54	
Black/mesh	704.628.27	
Green/nickel-plated	904.444.51	
White/brass-color polished	104.628.30	



HULTARP Container W12¼×D6¼×H4¾".		
Black/mesh	204.488.34	



HULTARP Dish drainer L11¼×W15¼×H14¾".		
Black	604.487.66	



HULTARP Hooks H2¾".		
Black	104.444.45	5pk
Nickel-plated	504.488.37	5pk
Polished/brass-color	104.487.78	5pk



HULTARP Magnet knife rack L15".		
Black	804.444.42	



HULTARP Rail L23½".		
Black	004.487.69	
Nickel-plated	404.628.24	
Polished/brass-color	504.487.76	



L31½".		
Black	204.487.73	
Nickel-plated	904.444.32	
Polished/brass-color	304.487.77	



HULTARP Papertowel holder W6×D6×H7".		
Black	604.444.38	

NEREBY series



NEREBY Container	
Natural	904.290.97



NEREBY Hanging organizer for accessories	
Natural	804.672.97



NEREBY Hanging storage	
Natural	004.915.69



NEREBY Bag	
Natural	504.667.32



NEREBY Wall shelf L15¾×D4¾×H3¾".	
Birch	904.659.24



NEREBY Rail Birch	
L15¾"	004.673.00
L23½"	904.763.43



NEREBY S-hooks H3¼".		
White	204.763.51	5pk



BEKVÅM Spice rack W15¼×D3¾×H3½".	
Aspen	204.871.75



GRUNDTAL Containers Ø3¼, H1½".		
Stainless steel	801.029.19	3pk



Sink accessories

Our sink accessories support all activities in and around the sink, helping you when preparing food and washing up. Plus, they help you to save both water and space.



NORRSJÖN Colander L16½×W7½×H3½". The colander is designed to rest steadily on the edges of the sink bowl. You can use it as a colander to rinse vegetables and salad or drain pasta. Fits NORRSJÖN sinks.

Stainless steel 003.397.13



NORRSJÖN Chopping board, L17¼×W16½". You can place the chopping board over the sink to get more space on the countertop and to hide dirty dishes. Fits over the bowl of NORRSJÖN sinks.

Solid oak 604.584.49



HÖGSMA Chopping board L16½×W12". Practical chopping board in bamboo that also functions as a lid on top of RÅSKOG cart.

Bamboo 904.466.19



VÄLVÄRDAD Dish drain Galvanized steel. Beige

L13¾×W6" 004.737.25



L20½×W13¾" 004.301.42



VÄLVÄRDAD Dish drying rack L12½×W4¾×H6¼". Fits 10 plates.

Stainless steel 604.737.13

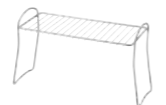

VÄLVÄRDAD Dish drying shelf L12½×W5×H7½".

Stainless steel 704.737.17

Kitchen islands and sideboards

Boost your storage space and kitchen functionality while adding a social focal point in your kitchen at the same time. A kitchen island or sideboard is great for many things.



TORNVIKEN Kitchen island

W28¾×D20½×H35¾".

Off-white/oak 003.933.71

Gray/oak 203.916.58



TORNVIKEN Kitchen island

W49¾×D30¾×H35¾".

Off-white/oak 403.916.57

Gray/oak 803.933.72



VADHOLMA Kitchen island

W31¼×D24¾×H35¾".

Black/oak 403.661.15



VADHOLMA Hanging storage W9¾×H24¾". The baskets collapse and fold away easily when not in use.

Black/mesh 104.613.50



VADHOLMA Kitchen island

W49×D31¼×H35¾".

Black/oak 203.591.54



VADHOLMA Kitchen island with rack

W49×D31¼×H88¾".

Black/oak 592.762.28



RIMFORSA Work bench

W47¼×D25¾×H36¼".

Stainless steel/bamboo 603.994.12

Stools and carts

A cart is a quick, easy and affordable solution giving you more flexible storage space.



GRUBBAN Step stool W15¾×D17¾×H16¾".

Black/birch	704.885.06
White/birch	804.802.08



New

BEKVÅM Stepladder, 3 steps W17¾×H24¾".

Black	304.846.71
-------	------------



NISSAFORS Cart W19¾×D11¾×H32¾". Use as an extra work area in the kitchen or bathroom, as practical storage in the hall or as a different bedside table in your bedroom.

White	404.657.33
Black	203.997.77



RÅSHULT Cart W11×D15×H25¾". This utility cart fits in the smallest of spaces and can be moved to wherever you need it. Use it as extra storage for all your kitchen utensils, desk accessories or for gloves, keys and mobile phones.

White	204.630.56
Gray	504.901.38
Turquoise	304.901.39



GROERYD Cart W28¾×D14¾×H31½". Lockable casters for high stability. Smooth tempered glass surface makes it easy to clean.

Bronze-color	304.989.46
--------------	------------



RISATORP Cart W15¾×D22½×H33¾". Perfect for storing fruits and veggies that are happier outside the fridge. The steel mesh ventilates so food stays fresh longer. Also handy as extra storage in any room.

White	202.816.31
-------	------------



BEKVÅM Cart W27¾×D19¾×H33½". Provides mobile extra storage, utility and work space. Solid wood is a durable natural material that you can sand and treat the surface as needed.

Birch	302.403.48
-------	------------



RÅSKOG Cart W13¾×D17¾×H30¾". Perfect for use in your kitchen, bathroom or where you need some extra storage space. The sturdy construction and four casters make it easy to move wherever you like. The adjustable middle section is easy to move to adapt to different storage needs. Stands evenly on uneven floors as the casters are adjustable.

White	203.829.32
Black	903.339.76



HÖGSMA Chopping board L16½×W12". Practical chopping board in bamboo that also functions as a lid on top of RÅSKOG cart.

Bamboo	904.466.19
--------	------------



STENSTORP Cart W16¾×D17½×H35¾". Two adjustable shelves in solid oak with grooves to keep bottles in place. Countertop is pre-treated with hard wax oil.

White/oak	402.019.16
-----------	------------



New

FÖRHÖJA Cart W39¾×D16¾×H35¾". You can quickly view and access what's inside because the drawers can be pulled out from both sides. Open storage with space for 9 bottles on each shelf. Solid wood is a natural material that is easy to repair, refinish and change whenever you like.

Birch	800.359.20
Birch/gray	504.867.25
Birch/white	804.867.24



New

FÖRHÖJA Kitchen cart W19¾×D16¾×H35¾". You can quickly view and access what's inside because the drawers can be pulled out from both sides. Solid wood is a natural material that is easy to repair, refinish and change whenever you like.

Birch/gray	805.278.66
------------	------------



KUNGSFORS Cart W23¾×D15¾×H35¾". The top part of the kitchen cart is loose and can be used separately as a tray. Lockable casters for high stability. Stainless steel is very easy to clean thanks to its smooth, non-porous and hard surface.

Stainless steel	803.349.24
-----------------	------------

Knobs and handles

Small details that make a difference!

Knobs and handles are like icing on the cake or your kitchen's jewelry. Enhance the style you like, refresh the look of doors and drawers, coordinate with the rest of your home — or simply change because it's fun.

Knobs and handles may seem small but they can help you to really personalize your kitchen. You can enhance a style to make your kitchen look more traditional or more modern. Mix them or match them perfectly and play with placements to create the finishing touches to the look you want in your dream kitchen.



FIXA Drill template

This simple tool helps you easily and accurately mark where you want to place your knobs and handles. 903.233.93



KNOBS AND HANDLES



BAGGANÅS Knobs Stainless steel

W½"	303.384.20	2pk
W⅓⅙"	103.384.21	2pk
W⅓⅙"	903.384.22	2pk



BAGGANÅS Knobs Brass-color

W½"	603.384.09	2pk
W⅓⅙"	803.384.08	2pk
W⅓⅙"	003.384.12	2pk



BAGGANÅS Knobs Black

W½"	303.384.15	2pk
W⅓⅙"	103.384.16	2pk
W⅓⅙"	903.384.17	2pk



ENERYDA Knobs Chrome-plated

L⅓⅙"	503.475.03	2pk
L1⅓⅙"	003.475.10	2pk
L1⅓"	803.475.11	2pk



ENERYDA Knobs Brass-color

L⅓⅙"	203.475.09	2pk
L1⅓⅙"	403.475.08	2pk
L1⅓"	603.475.07	2pk



ENERYDA Knobs Black

L⅓⅙"	303.475.04	2pk
L1⅓⅙"	803.475.06	2pk
L1⅓"	003.475.05	2pk



HISHULT Handles Porcelain White

L5½"	902.652.46	2pk
------	------------	------------

HISHULT Knobs Porcelain

W¾"	202.731.41	2pk
W1⅓⅙"	502.652.48	2pk



VINNÅSET Knobs Beech

Ø1⅓⅙"	504.342.94	2pk
-------	------------	------------



GUBBARP Handles White

L4⅓⅙"	003.364.32	2pk
-------	------------	------------

GUBBARP Knobs White

Ø1⅓⅙"	803.364.33	2pk
-------	------------	------------



SKÅRHAMN Drop handles Black/Chrome-plated

L2⅓⅙"	103.694.36	2pk
-------	------------	------------

SKÅRHAMN Knobs Black/Chrome-plated

Ø¾"	703.487.85	2pk
-----	------------	------------



NYDALA Handles Black

L6⅓⅙"	004.496.36	2pk
L13⅓"	404.496.39	2pk

NYDALA Knobs Black

Ø¾"	804.496.42	2pk
-----	------------	------------



ORRNÅS Knobs Stainless steel-color

W1⅓⅙"	302.361.53	2pk
-------	------------	------------



GRIBBOL Knobs 19/16"

Black	704.963.23	2pk
Brass-color	504.963.24	2pk
Chrome-plated	204.963.25	2pk



SKRUVSHULT Knobs Anthracite

L1⅓⅙"	805.074.82	2pk
L1"	705.074.87	2pk



NYDALA Handles Bronze-color

L6⅓⅙"	204.057.59	2pk
L13⅓"	604.057.57	2pk

NYDALA Knobs Bronze-color

Ø¾"	404.057.58	2pk
-----	------------	------------



ORRNÅS Handles Stainless steel-color

L6⅓⅙"	702.361.51	2pk
L9⅓⅙"	802.254.11	2pk
L13"	402.254.13	2pk



BAGGANÅS Handles Stainless steel

L5⅓"	703.384.18	2pk
L13⅓⅙"	503.384.19	2pk



BAGGANÅS Handles Brass-color

L5⅓"	003.384.07	2pk
L13⅓⅙"	203.384.11	2pk

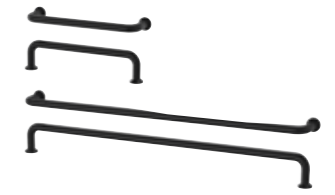

BAGGANÅS Handles Black

L5⅓"	803.384.13	2pk
L13⅓⅙"	603.384.14	2pk



ENERYDA Handles L47/16"

Black	703.475.16	2pk
Brass-color	203.475.14	2pk
Chrome-plated	603.475.12	2pk



ENERYDA Cup handles L31/2"

Black	503.475.17	2pk
Brass-color	903.475.15	2pk
Chrome-plated	403.475.13	2pk

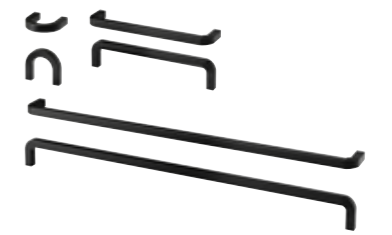

BORGHAMN Handles Steel

L1⅓"	003.160.47	2pk
L6⅓⅙"	203.160.46	2pk
L16⅓⅙"	403.189.78	2pk



GRIBBOL Handles L51/2"

Black	004.963.07	2pk
Brass-color	404.963.05	2pk
Chrome-plated	204.963.06	2pk



GALTHULT Handles Black leather

L2⅓⅙"	005.192.00	2pk
-------	------------	------------



ÖSTERNÅS Handles Tanned leather

L6"	403.488.95	2pk
L2⅓⅙"	203.488.96	2pk



SKRUVSHULT Handles Anthracite

L6"	505.059.55	2pk
-----	------------	------------



HACKÅS Handles Anthracite

L3⅓⅙"	303.424.79	2pk
L11⅓⅙"	503.424.78	2pk

HACKÅS Knobs Anthracite

L9⅓⅙"	803.397.90	2pk
-------	------------	------------



SÖRBYN Handles Stainless steel

L3⅓⅙"	904.503.38	2pk
-------	------------	------------

SÖRBYN Knobs Stainless steel

Ø1"	504.503.40	2pk
-----	------------	------------



BILLSBRO Handles White

L19⅓⅙"	203.343.14	2pk
L11⅓⅙"	903.343.15	2pk
L15"	903.343.01	2pk
L18"	603.343.07	2pk
L21"	003.343.10	2pk
L27"	903.343.20	2pk
L33"	703.343.21	2pk



KALLRÖR Handles Stainless steel

L8⅓"	503.570.02	2pk
L15⅓⅙"	103.570.04	2pk
L23⅓⅙"	303.570.03	2pk

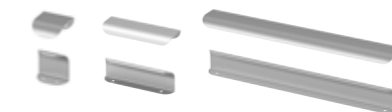

BILLSBRO Handles Stainless steel-color

L19⅓⅙"	603.235.92	2pk
L11⅓⅙"	803.236.28	2pk
L15"	603.236.29	2pk
L18"	403.236.30	2pk
L21"	203.236.31	2pk
L27"	003.236.32	2pk
L33"	803.236.33	2pk



TYDA Handles Stainless steel

L57⅓⅙"	701.169.31	2pk
--------	------------	------------



BILLSBRO Handle Stainless steel-color

L87"	103.235.99
------	------------



BILLSBRO Handle White

L87"	203.343.09
------	------------



VINNA Handles Stainless steel

L6"	201.166.98	2pk
-----	------------	------------

KNOXHULT KITCHEN

When basic functions and low price matter

To make it easy for you, we've already combined ready cabinets with doors, countertops, shelves and drawers. All you have to do is to pick the finishing touches, like knobs, handles and appliances. On the next pages you'll see what choices you have.



KNOXHULT is functional and easy to plan. Pick the combinations you like, then choose appliances, sinks, faucet, knobs and handles. Done!

Base cabinets



KNOXHULT Base cabinet with doors and drawer

You can install a sink and also adjust the space in the cabinet to your needs with two adjustable shelves. The frame and fronts are coated with foil which gives a scratch-resistant surface that is easy to keep clean. You can easily mount the door front in the right position, because the hinges are adjustable in height, depth and width. Stands steady on uneven floors because it has small adjustable feet. The countertop is $\frac{3}{8}$ " wider than the cabinet. W72×D24×H36".

White 003.722.60



KNOXHULT Base cabinet with doors and drawer

You can install a sink and also adjust the space in the cabinet to your needs with two adjustable shelves. The frame and fronts are coated with foil which gives a scratch-resistant surface that is easy to keep clean. You can easily mount the door front in the right position, because the hinges are adjustable in height, depth and width. Stands steady on uneven floors because it has small adjustable feet. Drawer with stop. The countertop is $\frac{3}{8}$ " wider than the cabinet. W48×D24×H36".

White 603.722.62



KNOXHULT Base cabinet with drawers

Drawer with stop. Drawer fronts are covered with foil, which gives a scratch-resistant finish. Stands steady on uneven floors because it has small adjustable feet. The countertop is $\frac{3}{8}$ " wider than the cabinet. W15×D24×H36".

White 403.722.63



KNOXHULT Corner base cabinet

The frame and fronts are coated with foil which gives a scratch-resistant surface that is easy to keep clean. The corner cabinet can be used in a left or right position. Stands steady on uneven floors because it has small adjustable feet. The countertop is $\frac{3}{8}$ " wider than the cabinet. W44×D24×H36".

White 703.722.71

Wall cabinets



KNOXHULT Wall cabinet with door

You can adjust the space in the cabinet to your needs with the adjustable shelf. The door is covered with foil, which provides a scratch-resistant surface. The door can be mounted to open from the left or right. W24×D12×H30".

White 503.722.67



KNOXHULT Wall cabinet with door

You can adjust the space in the cabinet to your needs with the adjustable shelf. The door is covered with foil, which provides a scratch-resistant surface. The door can be mounted to open from the left or right. W15×D12×H30".

White 903.722.65



KNOXHULT Wall cabinet with doors

The doors are covered with foil, which provides a scratch-resistant surface. Can be completed with a range hood. W30×D12×H12½".

White 905.002.77



Accessories



STÖDJA Flatware tray 11¼×19¾".

White 101.772.20



STÖDJA Utensil tray 6×19¾".

White 601.772.27



LAGAN Kitchen faucet Single lever. Swivel sprout 360°. H6¼".

Chrome-plated 700.850.29



STÖDJA Flatware tray 14¼×19¾".

White 701.772.22



SMÄCKER Flatware tray 12×10".

Gray 902.417.88



FYNDIG Single sink with strainer. Sink in stainless steel, a hygienic, strong and durable material that's easy to keep clean. Fits cabinet frames minimum W19¾". LILLVIKEN strain is included, but packaged separately. 18¼×15¾×5¾".

Stainless steel 691.580.07

SUNNERSTA MINI-KITCHEN

Flexible and affordable

With SUNNERSTA mini-kitchen you can create an open and welcoming kitchen even if space is limited. It's also great for dorm rooms and guest houses. Use the hooks and containers to keep track of utensils, and use the cart as a utility surface

when there's a lot going on in the kitchen. By adding our TILLREDA portable induction cooktop and compact fridge, you'll have everything you need. This affordable and flexible kitchen is easy to buy, get home, install and move to new places.



SUNNERSTA Mini-kitchen
LAGAN faucet and LILLVIKEN strainer included in the price, but packaged separately. W44 $\frac{1}{2}$ "x D22" x H54 $\frac{3}{4}$ ".

293.933.99



SUNNERSTA Rail with 4 hooks and 2 containers
White. L23 $\frac{3}{4}$ "x D5 $\frac{1}{2}$ " x H5 $\frac{1}{2}$ ".

404.545.60



SUNNERSTA Paper towel holder White. W12" x D5" x H2".

805.000.08



SUNNERSTA Container
White. Fits SUNNERSTA rail, cart and mini-kitchen. W4 $\frac{3}{4}$ " x D4 $\frac{3}{4}$ " x H5 $\frac{1}{2}$ ".

503.037.35



LAGAN Kitchen faucet
Single lever. Swivel sprout 360°. Chrome-plated. H6 $\frac{1}{4}$ ".

700.850.29



TILLREDA Portable induction cooktop
W10 $\frac{1}{2}$ " x D12 $\frac{3}{4}$ " x H2 $\frac{1}{2}$ ". White

104.935.20



TILLREDA Microwave oven
676 oz. W17 $\frac{1}{4}$ " x D13 $\frac{3}{8}$ " x H10 $\frac{1}{8}$ ". White

404.934.20



LIMITED WARRANTY GENERAL CONDITIONS

What is limited warranted?

The extent of the limited warranty given for each product is described alongside each product.

Duration of limited warranty

Each limited warranty lasts for the number of years stated against each product starting from the date of purchase.

What will IKEA do to correct the problem?

IKEA will examine the product and decide if it's covered under this limited warranty. IKEA will then, at its choice, either repair the defective product or replace it with the same or a comparable product. In these cases, IKEA will be responsible for the costs of repairs, spare parts, labor and travel for repair staff that IKEA incurs, provided that the product is accessible for repair without IKEA incurring additional expenditure to gain access. This will not apply in cases where repair work has not been authorized by IKEA. Any defected parts removed in the course of repair works will become the property of IKEA. If the item is no longer sold by IKEA, IKEA will provide an appropriate replacement. IKEA will decide at its discretion, what will constitute an appropriate replacement.

Conditions for the limited warranties

The limited warranties are valid from the date of purchase at IKEA. The original purchase receipt is required as proof of purchase.

Exclusions

The limited warranties do not apply to products that have been stored or assembled incorrectly, used inappropriately, abused, misused, altered or cleaned with wrong cleaning methods or wrong cleaning products. The limited warranties do not cover normal wear and tear, cuts or scratches or damage caused by impacts or accidents. The limited warranties do not apply if products have been placed outdoors or in a humid environment or if the products have been used for non-residential purposes (unless otherwise stated). The limited warranties do not cover consequential or incidental damages. Some states do not allow the limitation or exclusion of incidental or consequential damage, so this limitation or exclusion may not apply to you. For details see the limited warranty conditions and description for every product.

Care instructions

To be able to rely on this limited warranty you need to follow the specific care instructions for every product.

► You will find all care instructions in the IKEA stores and on the IKEA website: IKEA-USA.com

General legal rights

This limited warranty gives you specific legal rights. This limited warranty does not, in any way, affect the rights given to you by law.

How to reach us if you need service:

Contact your local IKEA store.

► You will find the address and phone number in the IKEA catalog or at IKEA-USA.com. Save your sales receipt as proof of purchase. Proof of purchase is required for the limited warranties to be valid.

► To find out more, pick up the limited warranty folders in your local store.

KASKER QUARTZ COUNTERTOPS



Limited residential lifetime warranty

- thickness of Caesarstone quartz slabs are ¾" or 1¼" with an allowable variance of +/- 1.5mm.
- Color may vary slightly from in-store samples.
- Quartz is not perfectly smooth, minor pitting is common and does not affect the performance or constitute a material defect.

Conditions for the limited warranty

- Owner must register warranty on or before 30 days of installation at www.Caesarstoneus.com.
- Original proof of purchase receipt is required.

What is covered under this limited warranty?

- Warranty against any manufacturing performed by the supplier, as well as the correct installation of the product.
- The warranty is effective only if the owner of the countertop is the occupant of an indoor single-family residence.

What is not covered under this limited warranty?

- The warranty does not protect against natural causes (e.g., fire, flood, tornado, etc.).
- Does not cover wear and tear such as stains, scratches, water spots and burns.
- Does not cover failure to comply with care instructions.
- Does not cover chips or damage from abuse or excessive impact.
- Does not cover any products moved from their original place of installation.
- Does not cover repair to electrical, tile or wall surfaces and plumbing modifications possibly required to install the custom countertop.
- Does not cover damages from alterations performed after initial installation.

Care instructions

- Clean with soap and water on a regular basis. For tougher dirt, use warm water and a damp cloth or a Scotch Brite delicate sponge pad with a small amount of non-abrasive cleaner that does not contain bleach.
- Trivets and hot pads must be used when placing hot skillets, pans, crock-pots or other heat generating kitchenware on the surface.
- Using cutting boards and taking care not to drop or move heavy objects on the surface will help to ensure long-lasting beauty.

Planning needs

- For KASKER custom quartz countertop planning needs and term and conditions, please see a co-worker at your local IKEA store.

KITCHEN FAUCETS

10

What is covered under this warranty?

The 10-year limited warranty is valid for all kitchen faucets at IKEA. This limited warranty applies to residential use only and covers defects in material and workmanship in all kitchen faucets. Our kitchen faucets are tested well beyond all relevant international standards and we use only top brand components to secure our 10-year limited warranty promise.

What is not covered under this warranty?

This limited warranty does not cover normal wear and tear, cuts or scratches, or damage caused by impacts, accidents or waterborne debris.

What will IKEA do to correct the problem?

IKEA will examine the product and decide, at its sole discretion, if it is covered under this warranty. If considered covered, IKEA through its own service operations, will then, at its sole discretion, replace it with the same or a comparable product. If the item is no longer sold by IKEA, IKEA will provide an appropriate replacement. It is IKEA that determines, at its sole discretion, what constitutes an appropriate replacement.

Exclusions

The limited warranties do not apply to products that have been stored or assembled incorrectly, used inappropriately, abused, misused, altered, or cleaned with wrong cleaning methods or wrong cleaning products. This warranty does not cover normal wear and tear, cuts or scratches, or damage caused by impacts, accidents or waterborne debris. It also does not apply to the filter/aerator which should be cleaned regularly or replaced when worn out. Follow our assembly instructions and care instructions carefully.

This limited warranty does not apply to products that have been stored, assembled or installed incorrectly, used inappropriately, abused, misused, altered, or cleaned with wrong cleaning methods or wrong cleaning products. This limited warranty does not apply if the products have been used for public use, outdoors or in a corrosive environment. It also does not cover accidental damage.

SEKTION KITCHEN SYSTEM

25

What products are covered under this limited warranty?

This limited warranty applies to residential kitchen use only. It covers defects in material and workmanship in the SEKTION kitchen system. This limited warranty

covers all of the following parts of the SEKTION kitchen system: • Cabinet frames • Fronts • Wall rail • UTRUSTA hinges • MAXIMERA fully-extending drawers • UTRUSTA shelves of tempered glass and melamine • Toe-kicks • Legs • Door dampers • Push opener for doors • Cover panels • Deco strips/moldings • Pre-cut countertops • Sinks except FYNDIG and VÄGLIG connecting rail.

Products not covered under this limited warranty:

- Knobs and handles

10

UTRUSTA wire baskets • UTRUSTA push opener electrical • VADHOLMA and TORNVIKEN open cabinet have a 10-year limited warranty.

KNOXHULT Kitchen system

KNOXHULT is not covered by this limited warranty.

ENHET KITCHEN SYSTEM

10

What is covered under this Limited warranty?

The 10-year limited warranty is valid for all ENHET products. This limited warranty applies to residential use only.

What will IKEA do to correct the problem?

IKEA will examine the product and decide, at its sole discretion, if it is covered under this limited warranty. If considered covered, IKEA through its own service operations, will then, at its sole discretion, replace it with the same or a comparable product. If the item is no longer sold by IKEA, IKEA will provide an appropriate replacement. It is IKEA that determines, at its sole discretion, what constitutes an appropriate replacement.

Conditions for the limited warranties

The limited warranties are valid from the date of purchase at IKEA. The original purchase receipt is required as proof of purchase.

Exclusions

The limited warranties do not apply to products that have been stored or assembled incorrectly, used inappropriately, abused, misused, altered, or cleaned with wrong cleaning methods or wrong cleaning products. This limited warranty does not cover normal wear and tear, cuts or scratches, or damage caused by impacts, accidents or waterborne debris. Follow our assembly instructions and care instructions carefully.

This limited warranty does not apply if the products have been used outdoors or in a corrosive environment.

For customers in the US only: some states do not allow the limitation or exclusion of incidental or consequential damage, so this limitation or exclusion may not apply to you.

Care instructions

To be able to rely on this limited warranty you need to follow the specific care instructions for every product. You will find all care instructions in the IKEA stores and on the IKEA web site: IKEA-USA.com

General legal rights:

This limited warranty gives you specific legal rights. This limited warranty does not, in any way, affect the rights given to you by law.

How to reach us if you need service:

Contact your local IKEA store. You will find the address and phone number at IKEA-USA.com. Save your sales receipt as proof of purchase. Proof of purchase is required for the limited warranties to be valid.

For more information, see the IKEA Kitchen Limited Warranty brochure at IKEA-IKEA.com/warranty.



From start to finish

This guide will help you through all the steps of measuring, planning, ordering, delivering and installing a kitchen.



Kitchen brochure

A brochure full of inspirational pictures of kitchens in all styles and sizes. Here you'll find everything from full-sized kitchens to all those little extras that make everyday life in the kitchen easier and more fun.



IKEA Kitchens and Appliances

In these buying guides you'll find all the products, details and prices to choose exactly what you need to make your dream kitchen a reality.

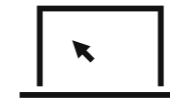

IKEA-USA.com/kitchens

On our webpage you'll find lots of inspiration and ideas to get the most out of your SEKTION or ENHET kitchen, whether it's a new one or an old that you want to freshen up. Plus, here you'll find all the products you can imagine to personalize and create the kitchen of your dreams.



IKEA Home Planner

Design the SEKTION kitchen of your dreams in a 3D environment and get a price on every detail as well as the total kitchen. Print out your drawings and product list at home, or save to the IKEA website. At the IKEA store you can discuss your design and get lots of advice and guidance from our kitchen experts. Learn more at [IKEA-USA.com/kitchenplanner](https://www.ikea.com/us/en/kitchenplanner)



ENHET kitchen configurator

You can rely on the ENHET kitchen configurator to make your purchase as fast and smooth as possible. Online you will find a display of the ready made complete kitchen solutions that our design experts have put together, based on years of experience from kitchen design. After having selected your favorite solution with a click, you can customize features, such as fronts, countertop, sink, faucet, knobs/handles and appliances. Learn more at [IKEA-USA.com/ENHETplanner](https://www.ikea.com/us/en/ENHETplanner)



SEKTION kitchen cabinets

This buying guide offers all you need to know to plan the position of your cabinets as well as the inside in the most efficient way.

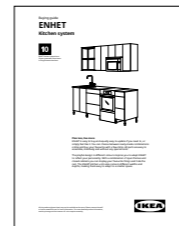

ENHET kitchen cabinets

This buying guide gives you an overview of all the ready-made solutions as well as all the parts and ranges that work with ENHET. Pick one up at your local IKEA store or read it online at [IKEA-USA.com/buyingguide](https://www.ikea.com/us/en/buyingguide)



SEKTION Installation guide

This guide provides you with tips and step-by-step instructions on how to install your kitchen on your own.

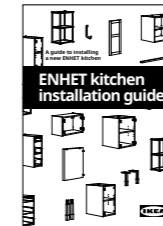

ENHET Installation guide

Our kitchen installation guides gives you tips and helpful information on how to install your new IKEA kitchen correctly. You'll find it at your local IKEA store and at [IKEA-USA.com/buyingguide](https://www.ikea.com/us/en/buyingguide)

More information and guidance

All brochures and guides are available to flip through on [IKEA-USA.com/buyingguide](https://www.ikea.com/us/en/buyingguide) Most are also available for pick up at your local store.

NEED HELP?

You can contact us in different ways:

Online: Read the FAQs at [IKEA-USA.com](https://www.IKEA-USA.com)—they might answer your question: [IKEA-USA.com/FAQ](https://www.IKEA-USA.com/FAQ)

In person: Speak to us in store—those friendly people in the yellow and blue shirts are ready to help you through your buying process.

By phone: If you ever need to talk to us in person, we're happy to answer your call. You can reach us over the phone at: 1-888-888-IKEA (4532)

Installation Services: Save time and effort with professional installation. For full details visit [IKEA-USA.com/kitchenservices](https://www.IKEA-USA.com/kitchenservices)

Special Information

This buying guide has been prepared by IKEA to better assist customers when purchasing products. Sources of supply and specifications are subject to change. Every reasonable effort will be made to ensure that all advertised merchandise is available in adequate supply. A high standard of accuracy has been sought in the preparation of this buying guide. Errors and omissions are always a possibility. Although IKEA cannot be held responsible, upon discovery of any error or omission, all reasonable steps will be taken to inform IKEA customers.

Country of origin

For all our products, we choose specialized manufacturers who can produce our components at the lowest price. A single item may consist of several components from different countries. Country of origin information is available on each component when you pick it up.

NEW

This symbol appears on products that are new in the buying guide this year. New items continue to arrive all the time, so visit the store often.

Stock Availability

We are working closely with our suppliers to replenish stock as quickly as possible, however, due to impacts on the supply chain caused by COVID-19, we cannot guarantee the availability of our cabinets and fronts. Lead times vary and some items could take up to six (6) months or more to receive. If you proceed with a kitchen cabinet and front purchase, we do not recommend starting the removal of your current kitchen or booking your contractor until you have received and inspected all items needed for the installation of your kitchen.

Valid as of July 1, 2022 posting. Prices are subject to change. Please see [IKEA-USA.com](https://www.IKEA-USA.com) or your local IKEA store for the most up-to-date pricing.

